



**The State of Nevada Purchasing Division
on behalf of National Association of State Procurement Officials (NASPO)
and the Multi-State Corrections Procurement Alliance (MCPA)**

Request For Proposal No.1901
for

INMATE KIOSKS

Release Date: **March 24, 2011**

Deadline for Submission and Opening Date and Time: **May 4, 2011 @ 2:00 P.M.**

For additional information, please contact:

Ronda Miller, Procurement Staff Member

(775) 684-0182

(TTY for the Deaf or Hard of Hearing: 1-800-326-6868

Ask the relay agent to dial 1-775-684-0182/V.)

This document must be submitted in the "State Documents" section/tab of vendors' technical proposal

See Page 22, for instructions on submitting proposals.

Contact Information

Company Name _____

Address _____ City _____ State _____ Zip _____

Telephone (____) _____ Fax (____) _____

E-Mail Address: _____

Prices contained in this proposal are subject to acceptance within _____ calendar days.

Contact Person _____

Print Name & Title _____

TABLE OF CONTENTS

1. OVERVIEW OF PROJECT / SCOPE OF WORK	3
2. ACRONYMS/DEFINITIONS	4
3. PROJECT DEFINITIONS	6
4. PROJECT TERMS AND CONDITIONS	109
5. COMPANY BACKGROUND AND REFERENCES.....	110
6. COST.....	125
7. PAYMENT	125
8. SUBMITTAL INSTRUCTIONS	126
9. PROPOSAL EVALUATION AND AWARD PROCESS.....	131
10. TERMS, CONDITIONS AND EXCEPTIONS.....	132
11. SUBMISSION CHECKLIST.....	136
Attachment A	State Documents Tab
Attachment B.....	State Documents Tab
Attachment I.....	State Documents Tab
Attachment K	State Documents Tab

A Request for Proposal process is different from an Invitation to Bid. The State expects vendors to propose creative, competitive solutions to the agency's stated problem or need, as specified below. Vendors may take exception to any section of the RFP, except Section 4 Project Terms and Conditions. Exceptions should be clearly stated in Attachment B (Certification of Indemnification and Compliance with Terms and Conditions of RFP) and will be considered during the evaluation process. The State reserves the right to limit the Scope of Work prior to award, if deemed in the best interest of the State NRS §333.350(1).

Prospective vendors are advised to review Nevada's ethical standards requirements, including but not limited to, NRS 281A and the Governor's Proclamation, which can be found on the Purchasing Division's website (<http://purchasing.state.nv.us>).

1. OVERVIEW

The State of Nevada, Purchasing Division on behalf of the National Association of State Procurement Officials (NASPO) and the Multi-State Corrections Procurement Alliance (MCPA) is seeking qualified manufacturers to provide Inmate Kiosks for NASPO/MCPA and all participating States. Vendors will provide and manage a system that will allow offenders in designated correctional facilities access to automated services with little or no assistance of staff.

The National Association of State Procurement Officials is a national association of Chief Procurement Officers that has established a procurement cooperative for state government departments, institutions and political subdivisions (i.e., colleges, school districts, counties, cities, etc.) for the NASPO Member States and territories of the United States.

Under terms of the NASPO Cooperative Memorandum of Agreement all fifty states and the District of Columbia may participate in this potential contract at their option and in accordance with their statutory requirements and rules.

Obligations under contracts that result from this cooperative procurement are limited to those states and other eligible purchasing entities that execute a Participating Addendum.

Financial obligations of Participating States are limited to the orders placed by the departments or other state agencies and institutions having available funds.

Participating States incur no financial obligations on behalf of political subdivisions.

Unless otherwise specified in the solicitation or by Participating States the resulting master price agreement(s) will be permissive.

Traditionally Department of Corrections (DOC) provides services to inmates located within its Institutions/Facilities across the state. Most of these services are requested by the inmates through DOC staff, requiring a significant staff time investment to complete transactions. Permitting inmates to obtain these services electronically in a secure correctional environment with little staff assistance will greatly improve the efficiency of both correctional and free-staff, allowing for a more efficient operation.

The process for this solicitation and eventual contract is as follows:

- The RFP will be drafted and issued by the State of Nevada;

- The RFP process will be governed by the Laws and Codes of the State of Nevada;
- A recommendation of award will be issued by the State of Nevada, based on the Evaluation Committee's results, to the NASPO Directors;
- If approved, the Master Service Agreement will be executed (Attachment C) by the Successful Vendors and the State of Nevada;
- Each state must then execute a Participating Addendum (Attachment H) with any unique Terms and Conditions. It is the awarded vendors' responsibility to negotiate with each participating state. Upon award vendor(s) must work with the state's existing commissary/inmate banking company i.e. Cashless Systems.

This RFP contains a multi-state scope and may result in more than one contract. The resulting contract(s) will be for a contract term of five (5) years, subject to approval of the NASPO Board of Directors anticipated to be June 1, 2011.

2. ACRONYMS/DEFINITIONS

For the purposes of this RFP, the following acronyms/definitions will be used:

<i>Confidential Information</i>	Any information relating to the amount or source of any income, profits, losses or expenditures, including data relating to cost or price submitted in support of a bid or proposal. The term does not include the amount of a bid or proposal. See NRS §333.020(5)(b).
<i>Division</i>	Nevada Department of Corrections (NDOC).
<i>Evaluation Committee/Sourcing Team</i>	An independent committee comprised of a majority of state officers or employees established to evaluate and score proposals submitted in response to the RFP pursuant to NRS §333.335.
<i>LOI</i>	Letter of Intent - notification of the state's intent to award a contract to a vendor, pending successful negotiations; all information remains confidential until the issuance of the formal notice of award.
<i>Lead State</i>	The State of Nevada and its state agencies, officers, employees and immune contractors as defined in NRS 41.0307.
<i>May</i>	Indicates something that is not mandatory but permissive.
<i>NAC</i>	Nevada Administrative Code
<i>Nevada</i>	The lead state for the purpose of this RFP
<i>NRS</i>	Nevada Revised Statutes
<i>NOA</i>	Notice of Award - formal notification of the state's decision to award a contract, pending Examiners' approval of said contract, any non-confidential information becomes available upon written request.

NASPO	The National Association of State Procurement Officials (NASPO).
Participating State	State(s) that have indicated intent to participate or who have executed a Participating Addendum.
Proprietary Information	Any trade secret or confidential business information that is contained in a bid or proposal or included in a particular contract.
Public Record	All books and public records of a governmental entity, the contents of which are not otherwise declared by law to be confidential (see NRS §333.333 and NRS §600A.030(5)) must be open to inspection by any person and may be fully copied or an abstract or memorandum may be prepared from those public books and public records.
RFP	Request for Proposal - a written statement which sets forth the requirements and specifications of a contract to be awarded by competitive selection NRS §333.020(7).
Shall/Must/Will	Indicates a mandatory requirement. Failure to meet a mandatory requirement may result in the rejection of a proposal as non-responsive.
Should	Indicates something that is recommended but not mandatory. If the vendor fails to provide recommended information, the State may, at its sole option, ask the vendor to provide the information or evaluate the proposal without the information.
State	The State of Nevada and its state agencies, officers, employees and immune contractors as defined in NRS 41.0307.
Subcontractor	Third party, not directly employed by the vendor, who will provide services identified in this RFP. This does not include third parties who provide support or incidental services to the vendor.
Successful Vendor	The organization/individual that is awarded and has an approved contract with the State of Nevada for the services identified in this RFP.
Trade Secret	Information, including, without limitation, a formula, pattern, compilation, program, device, method, technique, product, system, process, design, prototype, procedure, computer programming instruction or code that: derives independent economic value, actual or potential, from not being generally known to, and not being readily ascertainable by proper means by the public or any other person who can obtain commercial or economic value from its disclosure or use; and is the subject of efforts that are reasonable under the circumstances to maintain its secrecy.
Vendor	Organization/individual submitting a proposal in response to this RFP.
WSCA	The Western States Contracting Alliance (WSCA) is a cooperative group-contracting consortium for state government departments, institutions, agencies and political subdivisions (i.e., colleges, school districts, counties, cities, etc.) for

the States of Alaska, Arizona, California, Colorado, Hawaii, Idaho, Minnesota, Montana, Nevada, New Mexico, Oregon, South Dakota, Utah, Washington and Wyoming. WSCA is a subset of the National Association of State Procurement Officials (NASPO). NASPO is a non-profit association dedicated to strengthening the procurement community through education, research, and communication. It is made up of the directors of the central purchasing offices in each of the 50 states, the District of Columbia and the territories of the United States.

3. SCOPE OF WORK

In accordance with NRS 333.333, "Each request for proposals must include minimum requirements that the successful vendor must meet for the awarding of a contract pursuant to the provisions of this chapter. A contract may not be awarded to a vendor who does not comply with the requirements set forth in the request for proposals." All successful vendors must meet the requirements of this section.

This procurement contemplates a multi-state scope and may result in more than one contract. In determining an award, factors considered include but are not be limited to, pricing, range of applications offered; the favorability of the terms under which the vendor will do business; other vendor programs, capabilities, and product characteristics judged to provide additional value or administrative cost savings to the Participating States.

While the primary purpose of this solicitation is to select a vendor(s) who can meet the needs of Participating States, vendors may propose on one or more of the system requirements as indicated below. Vendors must clearly describe any geographical limits (e.g. by state name) if proposing a geographical area less than that of all Participating States.



A Participating State may evaluate and select a vendor judged to be in the best interests of the state involved. Administration of any such award(s) will be done by each of the Participating State(s) involved.

Violation of, or conflict with any codes or standard requirements throughout this RFP must be brought to the attention of the Participating States DOC's institutions/facilities prior to bidding, as each state operates slightly different as a result of the security levels at the locations.

It will be the awarded vendor's responsibility to provide proof to all Participating States' all sales/use taxes has been paid.

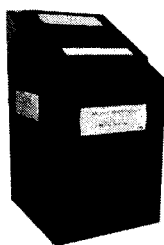

3.1 KIOSKS

3.1.1 Kiosk Solutions

Keefe Group Kiosk Solutions		
<i>Kiosk Type</i>	<i>Technical Environment</i>	<i>Solution Type</i>
Edge Inmate Self Service Kiosk 	<ul style="list-style-type: none"> • Email/Secure Messaging (turnkey) • Inmate Grievances • Inmates Commissary • Video Visitation (turnkey) • Inmate Scheduling • MP3-Download / Purchasing of Music (turnkey) • Phone Time Usage 	Turnkey <input checked="" type="checkbox"/> Standalone <input checked="" type="checkbox"/> Outside <input checked="" type="checkbox"/> Hardware Only
Secure Deposits Lobby Kiosk 	<ul style="list-style-type: none"> • Inmate Banking / Electronic Funds Transfer 	Turnkey <input checked="" type="checkbox"/> Standalone <input checked="" type="checkbox"/> Outside <input checked="" type="checkbox"/> Hardware Only
Music Manager Media Distribution 	<ul style="list-style-type: none"> • MP3 – Download / Purchasing of Music 	Turnkey <input checked="" type="checkbox"/> Standalone <input checked="" type="checkbox"/> Outside <input checked="" type="checkbox"/> Hardware Only

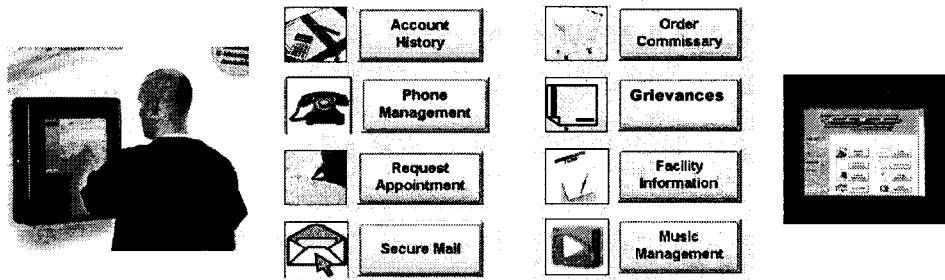
Edge™ Inmate Self Service Kiosk



Technical Environment	Solution Type
<ul style="list-style-type: none"> • Email/Secure Messaging (turnkey) • Inmate Grievances • Inmates Commissary • Video Visitation (2012 – turnkey) • Inmate Scheduling • MP3-Download / Purchasing of Music (turnkey) • Phone Time Usage 	<ul style="list-style-type: none"> Turnkey  Standalone  Outside  Hardware Only

Edge™ Kiosks in inmate living units

- **Include 8 native Keefe Group functions and can display additional html content**
- **Reduce stress on inmate services staff**
- **Leverage information to provide inmate self-help features**
- **Operate securely within the facility's intranet**

MODULES

Commissary orders will be placed through our state-of-the-art Edge Kiosks. The Edge is the leading offender self-service system in use by correctional facilities nationwide. It provides the functionality, convenience, ease of use and security that will make your facilities safer and more efficient. The efficiencies of our kiosk system continue to grow and be expanded upon. Taking DOC staff out of a lot of the everyday processes saves time and money. Keefe Group has committed to providing kiosks throughout the state.

The Edge allows offenders to perform a number of self-service functions and access facility information:

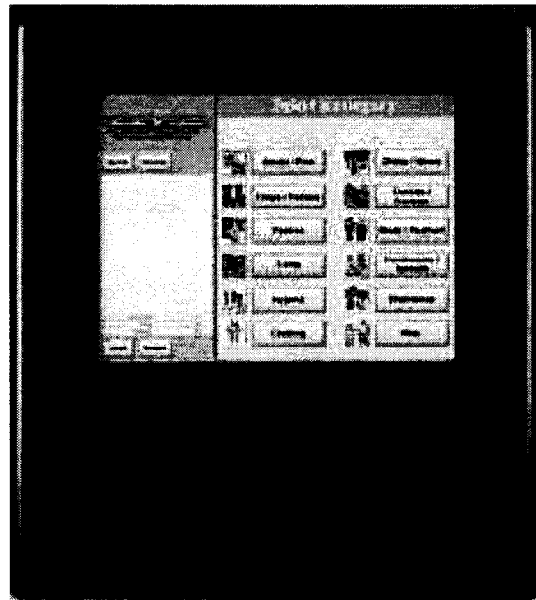
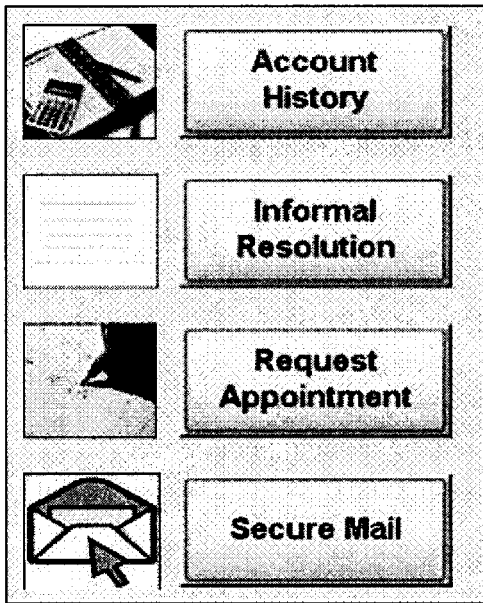

- **Account History**

Offenders can view account transaction histories and running balances without facility staff involvement.

Date	Type	Description	Amount	Balance
09/09/2008	<MEDICAL>	Payment for MEDICAL on 2008-09-03-11-42	-0.02	0.00
09/08/2008	KIOSK CASH	BOOKING KIOSK CASH DEPOSIT	0.02	0.02
09/04/2008	MISC WITHDRWL	VOID Payroll Deduction	2.00	0.00
09/04/2008	<MEDICAL>	VOID Payment for MEDICAL on 2008-09-03-1	5.15	-2.00
09/04/2008	MISC DEPOSIT	VOID Payroll Transaction	-200.00	-7.15
09/04/2008	MISC WITHDRWL	Payroll Deduction	-2.00	192.85
09/04/2008	<MEDICAL>	Payment for MEDICAL on 2008-09-03-11-42	-5.15	194.85
09/04/2008	MISC DEPOSIT	Payroll Transaction	200.00	200.00
09/03/2008	MISC WITHDRWL	Payroll Deduction	-0.15	0.00
09/03/2008	<MEDICAL>	Payment for MEDICAL on 2008-09-04-11-42	-14.85	0.15
09/03/2008	MISC DEPOSIT	Payroll Transaction	15.00	15.00

Account Information
Details as of 01/23

Inmate ID: 1

Name: TEST TEST

Available Funds: \$201.00

Debt Balance: 0.00

Log Out Main Menu Page 5 of 6

Account History

The online account history allows inmates to review their financial and purchasing history without the intervention of facility staff

K

- **Commissary Order Entry**

Offenders can create a “grocery” list via touch screen. Our system is unique in that it uses product pictures to allow offenders to choose their selections. The software is fully restriction capable.

Select a category

Order Commissary

The Visual Commissary Shopping Cart allows inmates to create and review their order requests well in advance of delivery date

K

- **Facility Information**

The facility can post schedules, menus, policies/procedures and general information to an online, read-only bulletin board.

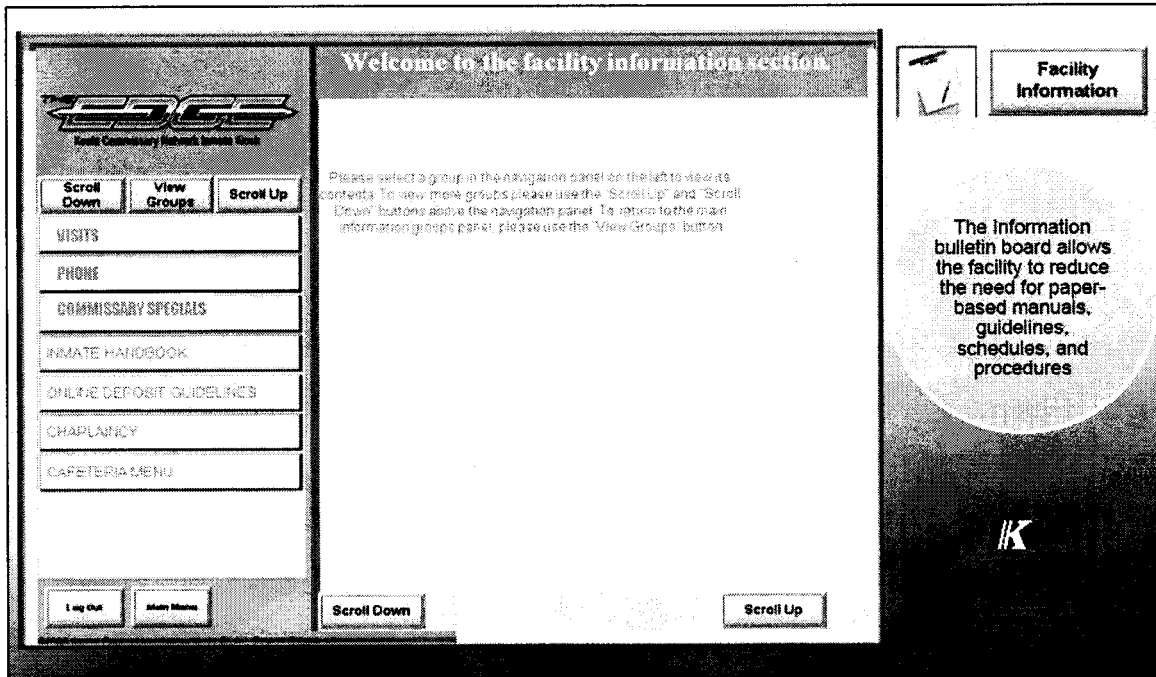

- **Offender Calendar/Appointment Request**

Offenders can use a personal calendar to request appointments for facility services. The facility can post offender information and approved appointments.

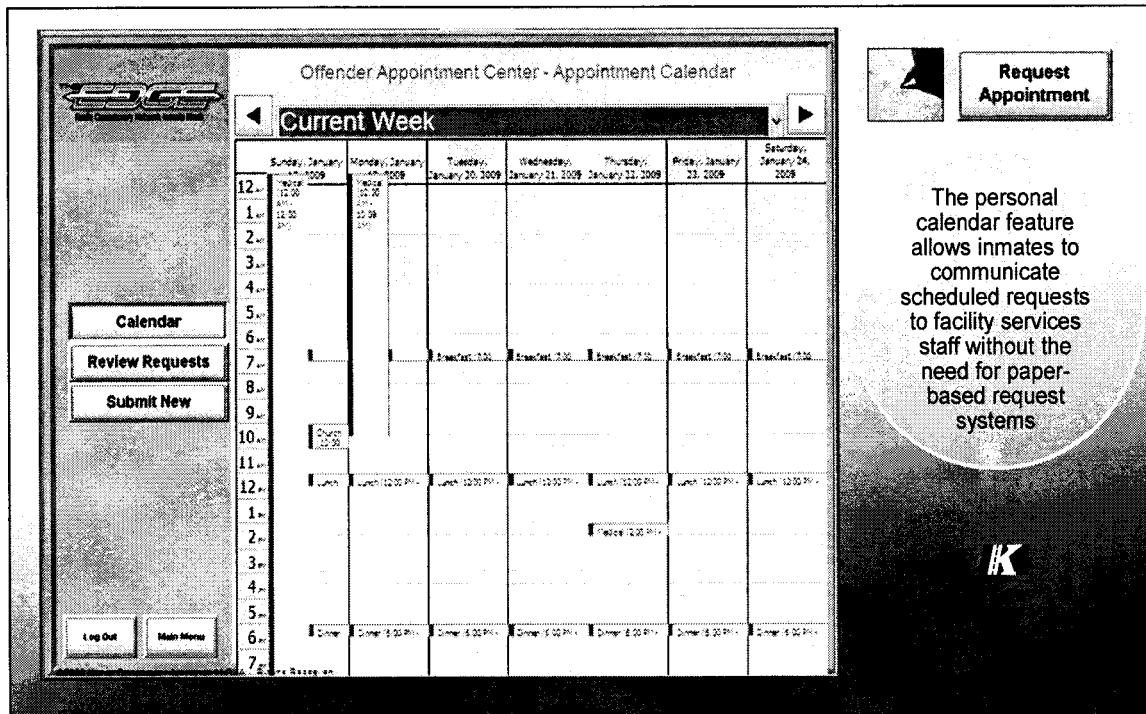

- **Informal Resolution**

Offenders can draft a request for an informal resolution to a grievance.

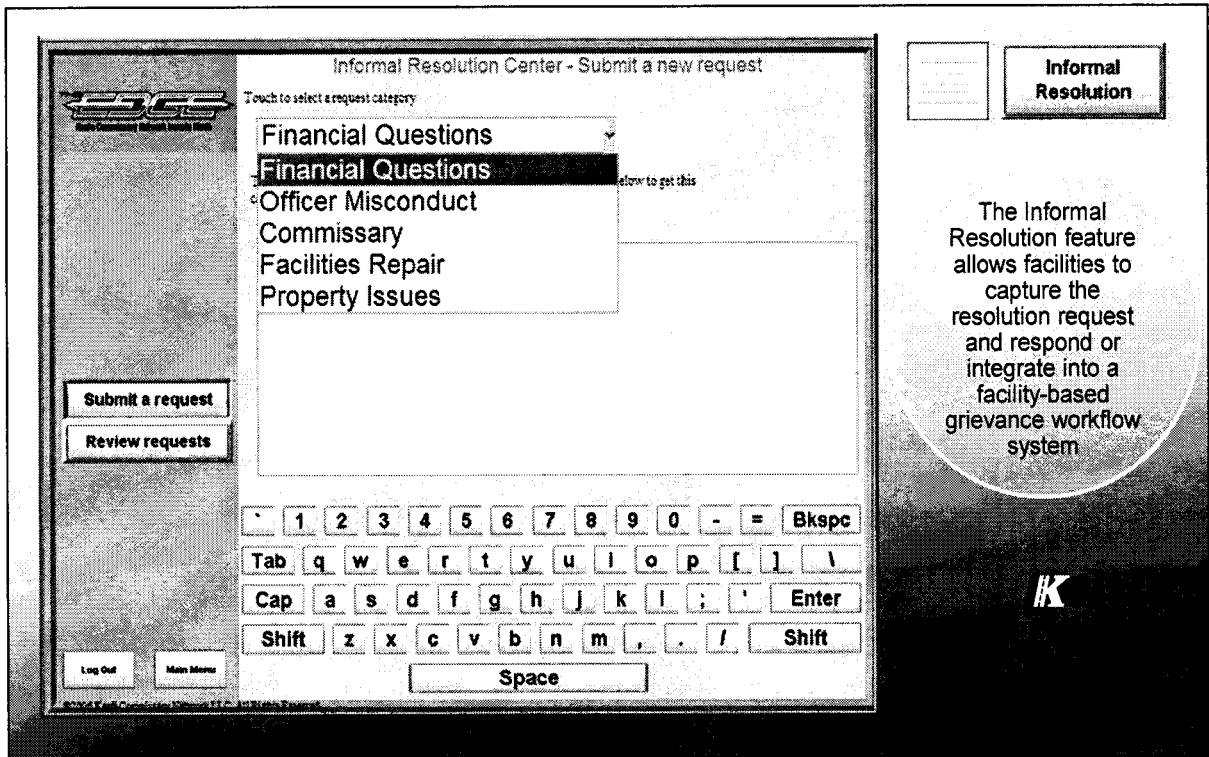

- **MP3 Download and ordering**

Offenders may download music, educational materials, photos and secure mail among other services offered through our kiosk and MP3 (Access to Entertainment) program.

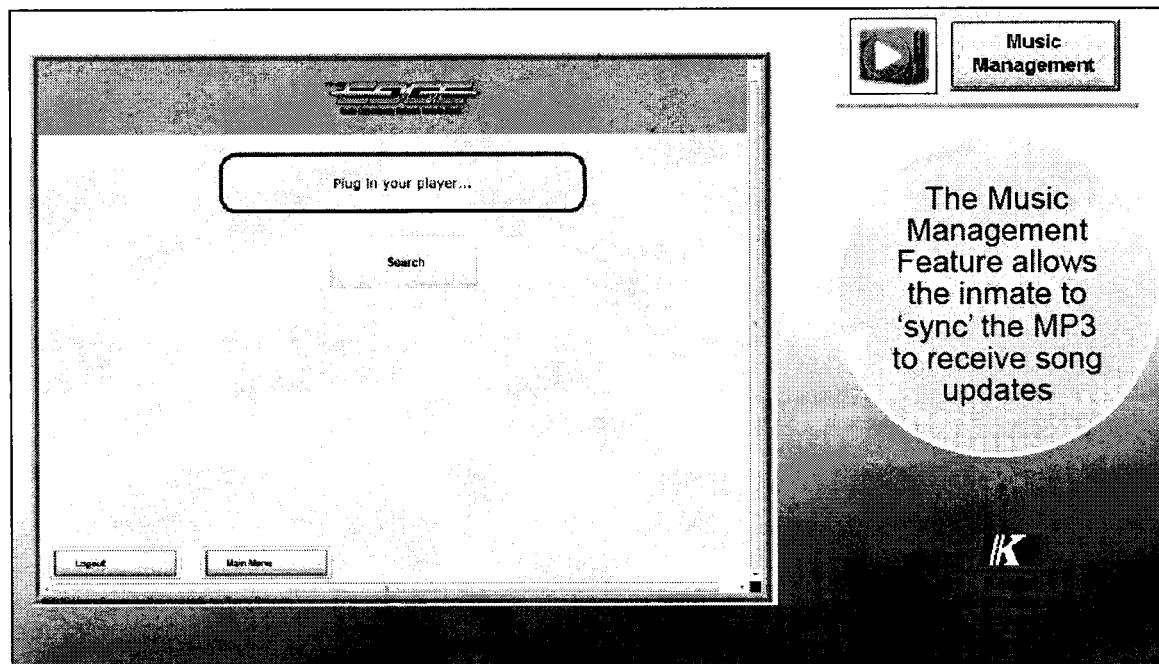

Administration:

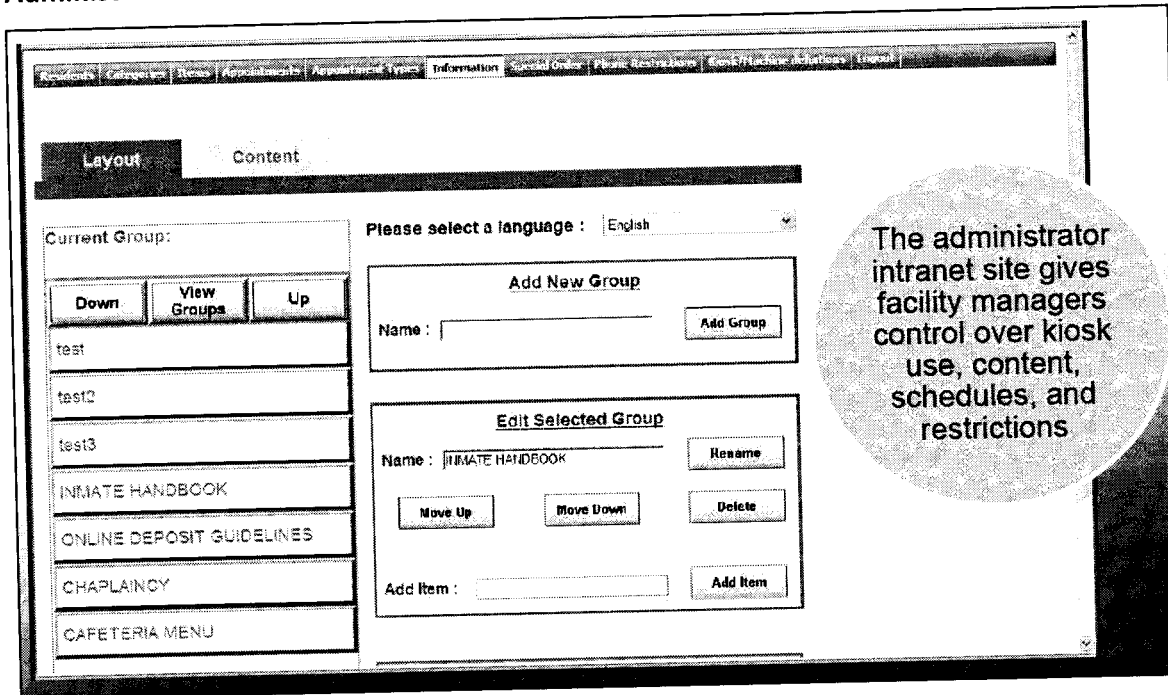

Additional Features:

- **Secure Mail**
Offenders can communicate with family members via facility-controlled messaging.
- **Phone Management**
Offenders can review phone charges and call history when the phone system is connected to the Keefe Group Offender Banking System.
- **Special Order**
Offenders can subscribe to special order items and occasions such as club activities.

Edge™ Inmate Self Service Kiosk Specifications

Edge™ Kiosk as Web Appliance

Edge™ kiosks are web workstations that are placed in inmate populations. An Edge™ kiosk allows the inmate to participate in a number of self service activities:

- Commissary Order Entry
- Account History Review
- Appointment Requests
- Kites and informal communications with staff (i.e. information requests)
- Grievances
- Message Exchange with Family Members and Friends
- MP3 song delivery
- Phone usage
- Video Visitation

Because the Edge™ kiosk is a web appliance, each kiosk needs to communicate with an Edge™ web server. The Edge™ web server must be located within a network that the Edge™ kiosk can be part of. The Edge™ web server must have access to inmate information so that the inmate can log in to the kiosk. Inmate information can come from the Keefe Group inmate banking system or from a partner inmate banking system.

Inmate Banking System – Edge™ Kiosk login and Account Lookup Information

The following graphic illustrates the relationship between the Edge™ Kiosks, the Edge™ Web Server, and the Inmate Banking System

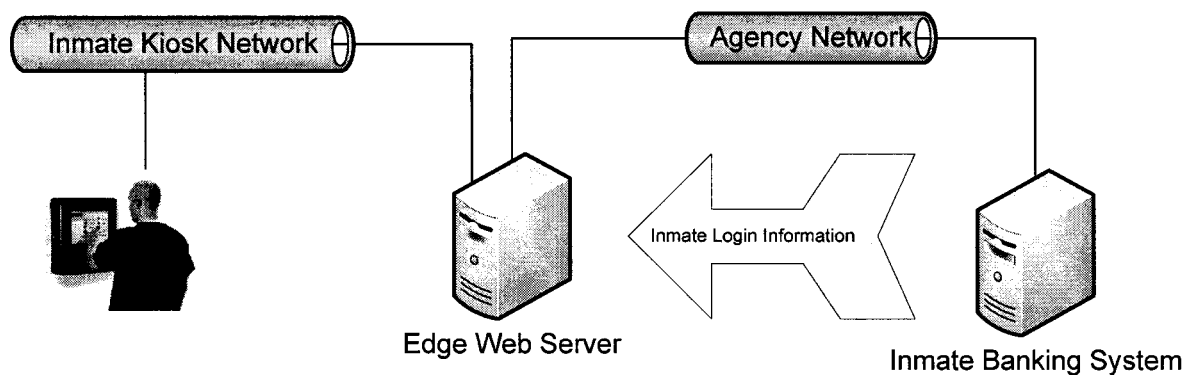

Network Cabling for Edge™ Kiosks

Because the Edge™ kiosks connect to a network, each kiosk must have either an Ethernet or a wi-fi connection to the network. Wi-fi connections allow many Edge™ kiosks to connect to a single wi-fi access point, reducing the number of Ethernet cabling runs. If using an Ethernet connection, the category 5 or 6 cable should run from a wiring closet to the kiosk location. At the kiosk location, the most typical method of connecting is to run the Ethernet cable in conduit to either the top or the bottom of the kiosk, and terminate the Ethernet inside the kiosk enclosure. At the wiring closet location, the Ethernet is most typically terminated to a wall jack or a distribution panel, and then a patch cable is used to complete the connection to the switch. The Edge™ server must be within the network that the wiring closet switch connects to. The following graphics illustrate both an Ethernet and a wi-fi network connection layout.

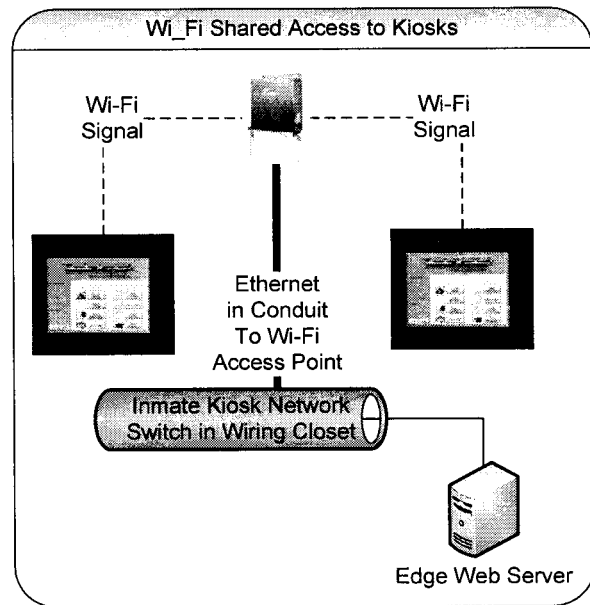
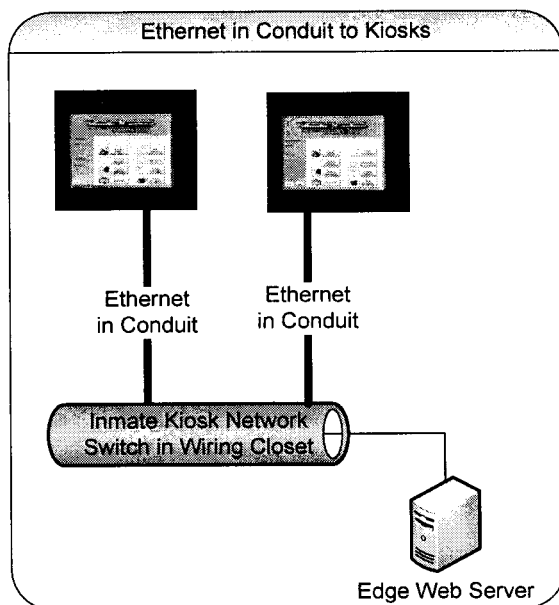

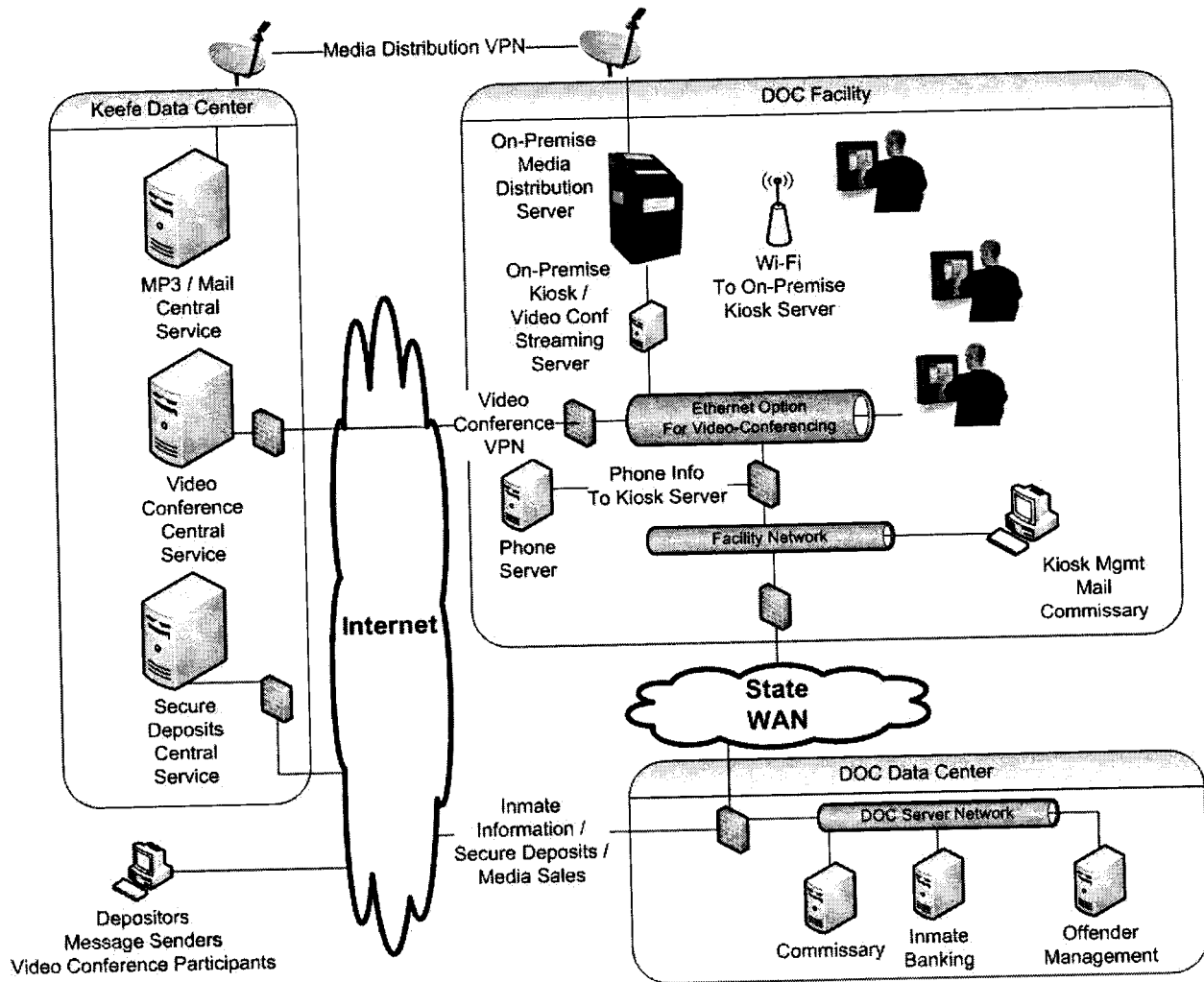

Computing Devices inside the Kiosk – Power Requirements

Each kiosk contains both a computer and a touch screen monitor. Each of these devices requires 110 volt AC power. The computer has a 19V AC to DC power supply. The monitor has a 12 V AC to DC power supply.

Specifications of the Wyse R90L Thin Client computer are as follows:



Processor:	1GHz AMD Sempron Processor
Memory:	Standard: 1G RAM / 1G Flash Maximum: 2G RAM / 4G Flash
I/O peripheral support:	One DVI-I Port One DVI-D Port Two PS/2 ports Two serial ports Six External USB 2.0 ports (2 front; 4 back) One Mic In One Line Out
Networking:	10/100/1000 Base-T Gigabit Ethernet 802.11 b/g/n and Bluetooth 2.0 (optional)
Power:	Worldwide auto-sensing 100-240 VAC, 50/60 Hz 65W, 19V DC
Power consumption:	Average 12.7 W
Dimensions:	250mm x 225mm x 53mm (9.8 in. x 8.8 in. x 2.1 in.)
Mountings:	Vertical or Horizontal (optional), VESA mount.
Temperature Range:	Horizontal position: 50 to 95 F (10 to 35 C) Vertical position: 50 to 104 F (10 to 40 C)

Specifications for the SecureTouch 15" Display are as follows:

ELO ET1537L 15" LCD Open-Frame Touchmonitor

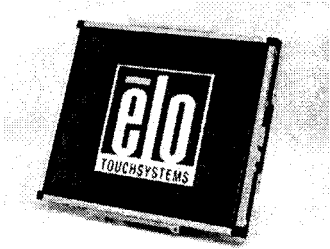

Active Matrix TFT LCD

Native Resolution 1024 x 768

Injection molded mini-bezel

Watertight seal

SecureTouch Surface touch Technology – pure glass

Transducers embedded on back of touchscreen glass

Scratch Resistant, but will continue to work if scratched

Height: 10.39 "

Width: 13.23 "

Depth: 1.61 "

Weight: 6.6 lb

Temp Range – 32 – 104 degrees F

Voltage / Current required: 12VDC +/- 5% / 2.5A max

Usable Screen Area: Horizontal 12 " x Vertical 9 "

MTBF 50,000 hours

Average Power usage including monitor – 17.2 Watts per hour

Supplying AC power to the Edge™ Kiosk Enclosure

Each of these power supplies plugs into a power strip supplied by Keefe Group and kept within the kiosk enclosure. To bring AC power to the enclosure, most agencies run the AC cabling in conduit either to the top or the bottom of the kiosk. Within the kiosk enclosure, Keefe Group provides a vacant wiring box for the agency to terminate the AC electrical cabling. The cabling should be terminated to a standard 110-volt AC outlet. Standard wiring specifications apply to the internally mounted AC outlet

Typical wiring instructions follow:

Strip off 1/2 inch of insulation from the end of black, white and green wires pulled out of the wall with a wire stripper. Loosen the spare (no wires attached) black and the white terminal screws on each side of the existing electrical outlet with a screwdriver. Hook the stripped end of the black wire around the gold terminal screw, and tighten the screw firmly. Hook the stripped end of the white wire around the silver terminal screw, and tighten the screw firmly. Loosen the green terminal screw, hook the bare or green wire around it, and tighten the screw firmly.

Following is a graphic of a completed AC outlet as it would be terminated within the Edge™ kiosk

Conduit and cable supplied by the Agency
Wiring Box integrated into the Edge™ Enclosure

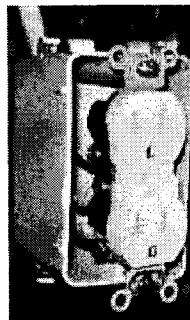
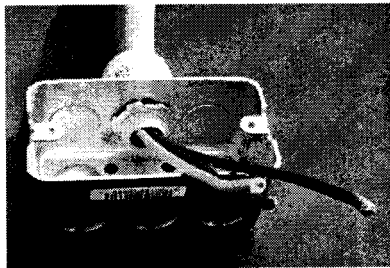

Although the termination is completely enclosed within the kiosk, some agencies also add a face-plate to cover the electrical cabling.

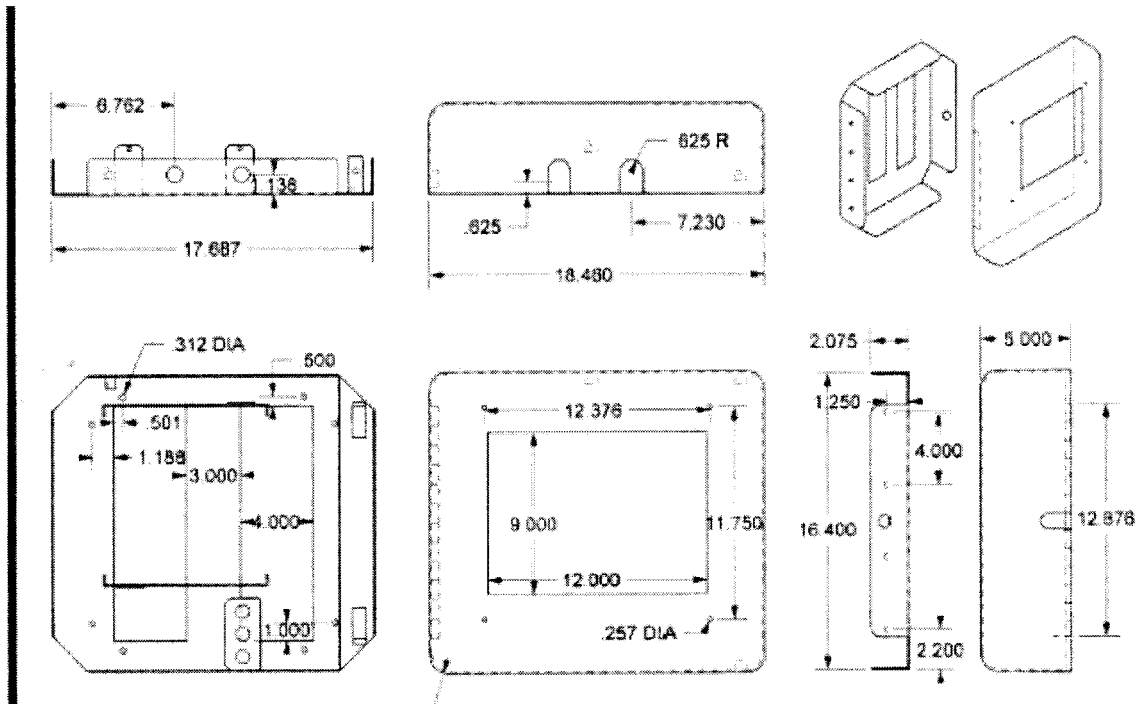

Wall-Mount Requirements for the Edge™ Kiosk

Mounting characteristics for the Edge™ Kiosk depend upon the material the wall is made of. Cinder block or concrete walls would require anchor bolts, and rock-board walls would be better served with toggle bolts. The following graphic shows the dimensions of the Edge™ kiosk enclosure and the location of the mounting bolts and internal electrical box.

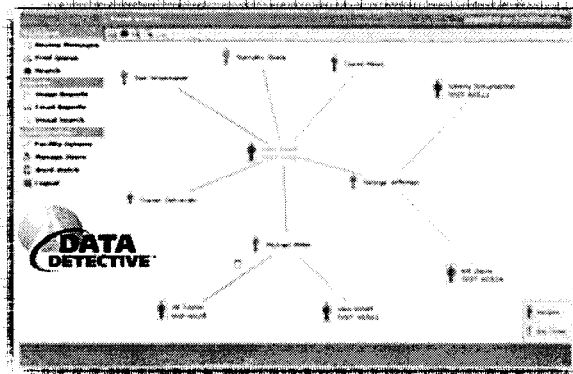
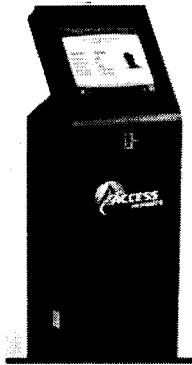

Secure Deposits™ – Lobby Kiosk with Data Detective Investigative Website



<p>Technical Environment</p> <ul style="list-style-type: none">Inmate Banking / Electronic Funds Transfer	<p>Solution Type</p> <p>Turnkey </p> <p>Standalone </p> <p>Outside </p> <p>Hardware Only</p>
--	--

Access Secure Deposits™ by Access Corrections™ allows family members to deposit funds into an inmate's account in the easiest, most efficient way available!

Friends and family have the ability to deposit funds through an array of options:

- Our toll-free, bi-lingual call center at 1-866-345-1884
- Online at www.accesscorrections.com
- Walk up kiosk located in the facility

The Turnkey service includes a facility management web site featuring **Data Detective:**

The only advanced software of its kind available to the corrections industry, Data Detective™ works in conjunction with Access Corrections™ technology services.

Data Detective™ is the most powerful investigative tool for identifying and connecting individuals on the outside who have interacted with multiple inmates. Interaction includes our services such as deposits made through our Access Secure Deposits™ program, as well as electronic mail and pictures through our Access Secure Mail™ program.

The Data Detective™ software automatically identifies key words and phrases for review and investigative purposes. Once a connection is made, the software will find and report any additional connections with other inmates and those on the outside.

Secure Deposits™ Kiosk Specifications:

Kiosk Enclosure

- Rugged 14 gauge steel
- High security locking system
- Front door access
- Door open detector
- Embedded camera
- Dimensions – h 53.75 in / w 18.5 in / d 25 in
- Electrical and Ethernet entry through base

Display Module

- 17" TFT active matrix LCD XGA (1024 x 768), 250 nit 4mm or 6mm tempered protective glass overlay
- Touch screen – Surface Acoustic, Resistive, Capacitive or IR (infrared)

Core Computing Module

- High Speed Intel® Processor and Motherboard
- 2 GB RAM
- 80 GB SATA HD
- 3D Graphics controller
- Win7 Embedded OS
- 10/100 GB Ethernet and 2.4 GHz WiFi capable
- Camera interface

Internal Peripherals

- Bill Acceptor
- Card Reader
- Cash Box
- Thermal Printer
- Camera

Monitoring

- Centralized monitoring of
 - Door Open
 - Cash Box Access
 - acceptor errors
 - cash box capacity
 - printer errors
 - printer paper
 - monitor errors
 - UPS
 - Application Errors
 - Network presence / heartbeat

Music Kiosk Media Distribution



<ul style="list-style-type: none"> • MP3 – Download / Purchasing of Music 	<p>Turnkey </p> <p>Standalone </p> <p>Outside </p> <p>Hardware Only</p>
--	---

Access to Entertainment vs. the Competition

Technical Data	Keefe Group	Competition
Proven in 8 statewide DOC's	√	x
Keefe Private Satellite Network	√	x
Browse & select Music from MP3 Player	√	x
Mortality Timer – Auto Shut Off	√	?
Fraud Lock	√	?
Security Shut Off	√	?
Programming/content to support re-entry	√	?
Corrections-Only Device	√	?
Supports Pictures and Secure Mail	√	?
No Transaction Costs	√	?
No Equipment, Network and/or Maintenance Cost	√	?

3.1.1.1 Turnkey Kiosks - all hardware and software necessary to provide any related services the vendor provides.

Agreed – Keefe provides three Turnkey Kiosks in response to this solicitation.

Edge™ Inmate Self Service Kiosk:

Turnkey Solutions

Commissary Sales and Fulfillment

Messaging

Media Distribution

Phone Usage

Video Visitation

Secure Deposits™ Lobby Kiosk:

Turnkey Solutions

Hosted Deposits

Bank Transfers

Secure Media™ MP3 Distribution Kiosk:

Turnkey Solutions

Player Sales and Fulfillment

Prepaid Media Sales and Fulfillment

3.1.1.2 Stand Alone Kiosk - all hardware and software necessary to provide unattended transaction processing of applications.

Agreed – The Keefe Software and Hardware for the Edge™ Inmate Self Service Kiosk, the Secure Deposits™ Lobby Kiosk, and the Music Manager™ MP3 Distribution Kiosk is sufficient to provide unattended transaction processing of applications.

3.1.1.3 Outside Kiosk - located outside and be able to withstand weather and the elements; rain, snow, wind, sun, etc. Kiosks should withstand temperatures from -20 degrees to 110 degrees with up to 100% humidity.

Agreed – the Keefe outside Edge™ Inmate Self Service Kiosk and the Keefe outside Music Manager™ outside Media Distribution Kiosks meet the requirements of section 3.1.1.3 of this solicitation. The Keefe Secure Deposits™ Lobby kiosk is not intended for outdoor use, and instead will be located in the lobby of the correctional facility.

3.1.1.4 Hardware Only Kiosk - all related hardware as needed to implement kiosk solution. Kiosk should contain a touch screen; however, a durable security centered keyboard will also be considered especially supporting disabled inmates who could not access the kiosks.

Note: If proposing this type of kiosk, vendor to be responsible for the project, with a sub-contractor(s) as needed to complete the installation as quoted.

Exception – Keefe is not offering a hardware only solution for the Edge™, Secure Deposits™, or Music Manager™ kiosks in response to this solicitation. To limit the potential for damage, our Edge Kiosk has been intentionally designed without a keyboard.

3.1.2 Kiosk Enclosure

The successful vendor shall provide a kiosk design to be of standalone style for inside/outside locations. The kiosk enclosure/housing needs to be self contained, rugged and secure. No crevices that can enable inmates to damage or spill into the enclosure and damage the kiosk.

This requirement is not mandatory and will be determined by the type of kiosk proposed. If there are no enclosures, vendors are to explain in detail the plan for mounting and security of the hardware.

Kiosk enclosures may, but not limited the following:

3.1.2.1 Heavy duty locking mechanisms, hinges, door mechanisms capable of resisting inmate tampering and vandalism.

Agreed – Keefe’s kiosks meet this requirement.

3.1.2.2 Hardware must be contained in the kiosk enclosure.

Agreed – Keefe’s kiosks meet this requirement.

Enclosure:

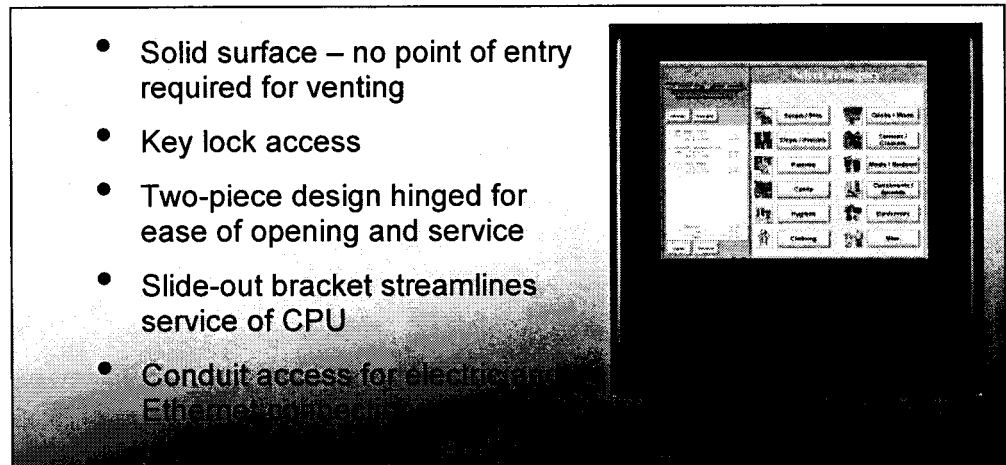

3.1.2.3 The kiosk should have the ability to be anchored to the floor and or the wall. The vendor shall ensure that each kiosk can be easily unsecured from the floor or the wall by authorized personnel.

Agreed – Keefe’s kiosks meet this requirement.

3.1.2.4 The kiosk enclosure must be of a neutral color and easily cleaned.

Agreed – Keefe’s kiosks meet this requirement.

3.1.2.5 The kiosk shall not bear company names or logos.

Exception – The Secure Deposit™ and the Music Manager™ Turnkey solutions contain logo information to assist end users with contact and/or billing information. The Secure Deposits kiosk is located in the lobby of the correctional facility and is used by family and friends on the outside. The Edge™ inmate self service kiosk does not contain company names or logos.

3.1.2.6 Pictures, artist renderings and drawings of the proposed kiosk design shall be included with the proposal.

Agreed – Keefe Group has included pictures in section 3.1 of all proposed kiosks.

3.1.2.7 Vendor must ensure that battery-backed alarms with detectors on all openings are implemented where entry might be forced. Kiosk alarms must be:

- Manually set to ring for a period of time with shrill alarm;
- Capable of activation/deactivation at a remote location designated by the institution; and
- Proven not to provide false signaling regarding remote alarm.

Agreed – Keefe can engineer a battery-backed alarm with detectors on all openings where entry might be forced into each of its kiosk solutions.

3.1.2.8 Kiosks must have sealed opening(s) for power and phone lines as needed.

Agreed – Keefe’s kiosks meet this requirement.

3.1.2.9 Kiosks have adequate ventilation to include fans if needed for components.

Agreed – Keefe’s kiosks meet this requirement.

3.2 TECHNICAL ENVIRONMENT

3.2.1 Kiosk Applications

At minimum, the operating system/applications should allow the Participating States DOC the ability to modify. Vendor shall ensure each kiosk is maintained on the most current version of the vendor’s systems of operation, with no more than two versions at any one-time across all kiosks.

Vendor shall provide the method of insuring inmate ID security. Methods could include fingerprint scan, or other biometric possibilities, ID card scanning (magnetic or barcode), and or voice options. (Refer to section 3.3 of this RFP)

Vendors to describe in detail the ability to provide at minimum the following functionality within their software application:

3.2.1.1 Email/Secure Messaging – Incoming/outgoing is screened by the system using keyword search before download is allowed. Keyword

screening would evaluate risk level of e-mail. Unacceptable or questionable (moderate to high risk) e-mail is held or staged at a central location computer for DOC approval before it is available for offender delivery or download. At minimum; Keyword search may be edited at any time. Offender email must be storable by vendor or transferrable to DOC Storage.

Keefe Group's Secure Mail program is proven and is currently deployed at the Mississippi DOC – 16,000 inmates, Arkansas DOC – 13,000 inmates, Idaho DOC – 4,000 inmates and has a pilot running at the Massachusetts DOC. It is also getting ready to launch at the New Hampshire DOC – 2,400 inmates.

Sent messages will pass through our Word Watch filter software that will scan each message for words or phrases that are predefined by each facility. Keefe Group has a complete database of pre-existing words and phrases that we will provide to the facility. However, our Word Watch software is completely customizable by each facility allowing them to enter words and phrases that are specific to their offender population. Authorized staff is able to add or remove specific words and phrases as deemed necessary as well as change point levels they wish to assign to certain words.

Once the Word Watch scan is complete, each message is scored and displayed using a stop light tree system making it very easy for staff to see what messages they need to focus on:

- **GREEN** = no words or phrases found
- **YELLOW** = some words and phrases found
- **RED** = significant number of words and phrases found



Mississippi DOC

Review Messages - CMCF Logged in as: LIZ SMITH

Click on a message to review Current Queue: CMCF

<input type="checkbox"/>	Date Received	From	To	Score
<input type="checkbox"/>	12/20/2009 3:03 AM CST Subject: Send in love	EMMA BANKS	JACKIE BANKS (105624)	20
<input type="checkbox"/>	12/20/2009 7:14 AM CST Subject: Light	Linda Barlow	KIM WATKINS (152749)	5
<input type="checkbox"/>	12/20/2009 7:59 AM CST Subject:	anna mathema	MELISSA CORRELL (118520)	5
<input type="checkbox"/>	12/20/2009 8:05 AM CST Subject: Hey 211153	Shonda Alexander	BETHANY WHITE (181159)	5
<input type="checkbox"/>	12/20/2009 8:41 AM CST Subject:	Yanick Fawcett	SHILDA CRAY (135272)	5
<input type="checkbox"/>	12/20/2009 8:45 AM CST Subject: VICTIMIZATION	MARGARET DUKE	GEORGE DUKE (154199)	5
<input type="checkbox"/>	12/20/2009 10:19 AM CST Subject:	Shonda norrigan	ANNA WILCK (67182)	10
<input type="checkbox"/>	12/20/2009 10:27 AM CST Subject: Hey Love	EMMA BANKS	JACKIE BANKS (105624)	25
<input type="checkbox"/>	12/20/2009 7:57 PM CST Subject: Hi friend	Liz Smith	JOHN SMITH (132780)	5

Copyright © 2009 Access Corrections. All rights reserved.

After the message has passed through the Word Watch filter system, staff can then click on it for further review. Once the message has been opened up, all words or phrases that have been flagged by the Word Watch software will automatically be highlighted for quick review. The facility staff can then select whether it is approved or rejected. If approved, the message will be sent to the kiosk for viewing by the inmate. All messages will be stored indefinitely so if they are ever needed for later investigative purposes authorized staff can easily recall messages & photos in-real time from the Keefe Group provided computer at each facility or any computer with internet access.



TESTKCN - KCN LAB TEST CUSTOMER

Please select which facility you would like to use: TESTKCN - KCN LAB TEST CUSTOMER

Review Messages - Default Logged in as: Dan Dattarider, current time: 05/17/2010 1:50 PM CDT

Review message

Date: 05/17/2010 1:50 PM CDT
From: Michael Miller
To: BOBBY SMITH (TEST-001)

Subject: Hey

Body:
 Bobby,
 I can't wait til you **break out**. We're going to have so much fun. I just met this **great** salesman that has great access to **weapons**. We can get any **gun** we want. It is going to be great. We are going to have to celebrate by smoking some **weed**. I hope your doing well. See ya soon.
 John

Messages that are filtered and defined as “green” can be sent directly to the kiosk without human interaction (if the facility chooses this option or they can be manually approved like all other messages). Messages classified as “yellow” can be reviewed by facility staff for approval and all “red” messages can be denied. This system is completely customizable to each facility, based upon the preferred approval method.

3.2.1.1.1 Email services, including, restrictions of senders/receivers, and keyword search capabilities on both incoming and outgoing messages. Please give your ability to provide the above.

Keefe Group offers to the facility an “Auto Escalate” feature. This allows for messages sent to specified inmates or messages from specified customers to automatically escalate from mail room staff to a particular investigator or facility staff. This allows investigators to increase the depth of investigation of a specific inmate or customer and limit the ability of only certain staff to see these messages.

The “Auto Escalate” feature can be setup three (3) different ways:

- When a message hits a certain point value
- When it is a message from a specified customer
- When it is a message to a specified inmate

Keefe Group also offers to the facility the option of an “Approved Visitor List”. This allows the facility to designate only certain individuals approved by the facility to send messages to a particular inmate. This feature can be turned on or off and is customizable.

Messages can also be search by keywords, date range, sender or receiver.

3.2.1.1.2 Capability for the DOC to manage email approvals at either an institution level as well as a state level.

Keefe Group has created a specific facility website for facility staff to view and approve/deny messages and photos. Authorized facility staff will have access to log-in to the website and view an inbox containing all pending messages and photos for that facility. The authorized user is able to sort the messages by the: To, From or Subject fields and will be able to open each message to review for content.

The facility will be able to set up multiple user IDs for facility staff to log on to the facility website to review messages. The facility will also have the ability to set-up different users with different privileges and control levels. Approvals can be done at an institution level as well as the state level. Keefe Group will also have the ability to track and monitor the activities of the facility staff while logged on to the secure facility website. This will allow the facility to monitor who approved and denied each message.

3.2.1.1.3 Systems ability for the email to include photos. System to allow for separate view of photos from messages and the ability to reject/accept any combination of those.

NOTE: Photos will increase stress on the network.

Keefe Group's Secure Mail program does not allow any type of attachments to be sent with a message. All pictures are sent as a separate message. This prevents a picture attachment accidentally being overlooked and approved without review. It also prevents a message that may be approved but the attached picture not be approved or vice versa causing a lot of confusion and extra work for facility staff. With Keefe Group's program, the picture will arrive separate from the message so one can be rejected without affecting the other. By allowing picture messages, the facility will not need to worry about the costly and time consuming process of returning an unapproved photo and it will help to eliminate contraband.

3.2.1.1.4 Estimated impact of email/messaging on the DOC network.

Keefe's Secure Mail two-way message content is text based and is transported via HTML. Picture Mail is one-way only and may be delivered either to the Edge™ Kiosk over HTML or to the MP3 Player by direct connect to the Edge Kiosk. Network traffic under these conditions would be less than typical email traffic by non-inmate end users of State DOC networks.

3.2.1.1.5 Provide a plan for data lines should capabilities at the institutions be limited as a result of this implementation.

Keefe's Music Manager™ media distribution system creates a self-contained VPN network using VSAT technology. When deployed with the Secure Mail solution, message delivery and dispatch may be negotiated from Edge™ kiosks or Media Players through the VSAT VPN connection to Keefe's Central Services platform. This deployment model obviates the need for ISP-type connections to support messaging traffic.

3.2.1.1.6 Internet access/direct e-mail reply is not allowed within the Nevada Department of Corrections. Vendor to detail how this could be managed with their systems.

As in response to 3.2.1.1.5 above, the VPN network established by the Music Manager™ VSAT implementation provides an alternative transport mechanism to Keefe's Central Services environment. The messaging system itself is not an e-mail hosting service, but rather a message exchange service in which the Edge™ kiosks do not browse the internet. Instead the Edge™ web server provides an on-premise broker service to communicate pending outbound messages and to display approved inbound messages. The Edge™ kiosk itself communicates only with the the Edge™ web server.

3.2.1.1.7 Vendor to propose both viewing and printing options available for the proposed kiosk.

Keefe Group has multiple types of message delivery options available to the facility. Outlined below are three different options.

Option 1 – Print-Deliver with Scan-Back Reply - Approved messages/photos are printed and delivered with the option for inmate's to send a hand written scanned reply. Keefe Group will provide all printers, paper and toner.

Option 2 – Edge™ Inmate Kiosk – Approved messages/photos are viewed and replied to from inmate kiosks where applicable.

Option 3 – MP3 Player – Approved messages/photos are downloaded to a Keefe Group MP3 player to be viewed and replied directly on the player. This option provides the facility the most efficient and flexible EIM program available.

Print- Deliver- with Scan-Back Reply

The Print- Deliver- with Scan-Back Reply method allows the Customer to send a text or photo message to the inmate, using the Keefe Group secure website described above. Once the Customer has completed the message it automatically passes through a filter process that scans each message for words and phrases that are predefined by the facility and then is placed in the facility’s inbox on Keefe Group’s secure website. All green messages with no flagged words and phrases are automatically sent to print (if the facility chooses this configuration). All messages containing flagged words and phrases (with a Yellow and Red rating) remain in pending status until authorized staff denies it or approves it for printing. The message or photo will print out in the facility mailroom on a Keefe Group supplied printer.

Scan-Back Reply

A Scanned Reply will be offered as an optional two-way add-on to the Print-Deliver service. This feature allows the inmate to respond to the sender of a message. When the incoming approved message is printed, an additional scanned reply form will be printed with the message. The original message from the Customer will have a note on it stating that a scanned reply form is included with the message. The reply form will have a barcode on it that contains the original senders necessary identification information encoded in it so the reply message can be automatically routed to the sender. The form will display From (inmate), To (original sender), Subject (RE: Original Message Subject), and Date/Time. A reply form will be one page, one sided only and include a box around the area where the inmate can write. The form will be delivered to the inmate with the original message. The inmate will then write his/her reply on the form and turn it into the facility staff for processing.

<p>Subject: Re: Test Scan Reply 1 To: KCN Developer From: BENJAMIN JOHNSON Printed: 06/07/2010 02:37 PM CDT Expires: 06/17/2010 12:00 AM CDT</p>	 127D2E3D8
<div style="border: 1px solid black; height: 120px;"></div>	

Upload

Once the reply forms have been turned in to the facility staff, they can be uploaded to Keefe Group’s Secure Mail website using the printer/scanner provided by Keefe Group. The facility staff simply scans all reply forms for that day all at once. There is no sequence or other sorting needed. The batch of reply forms are automatically batched into a single PDF file by our system. Then when the staff uploads the PDF, the system will parse each reply form into a separate reply message and identify the

original sender information using the barcode on the form. After uploading is complete, the website displays a confirmation screen. The confirmation screen displays a list of the messages that were uploaded (Message ID #, Page #, From, To, Subject, and Date/Time). The staff can click on a message in the list to see a preview of what the scanned message looks like.

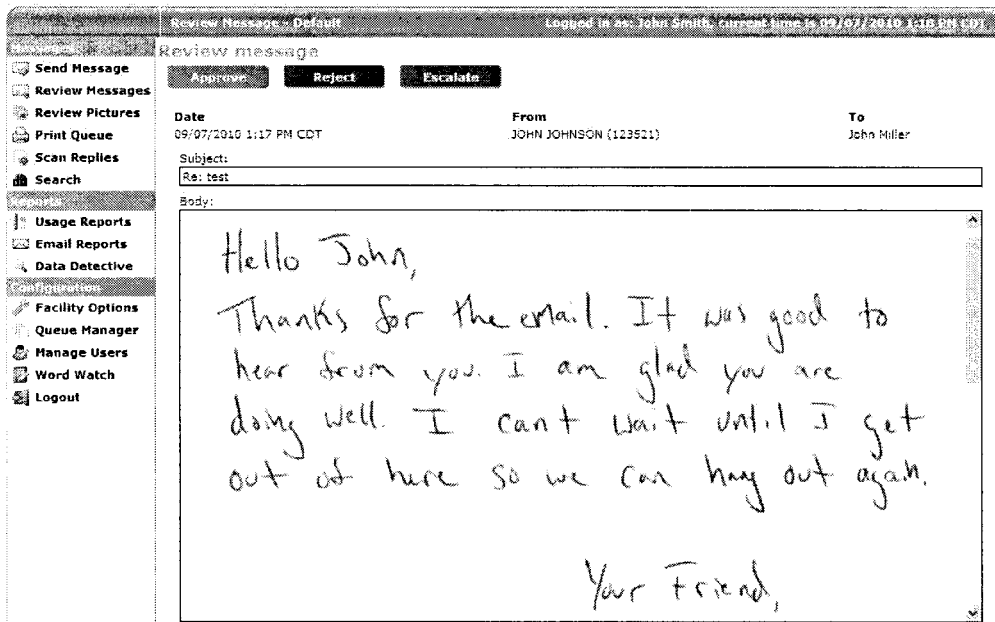
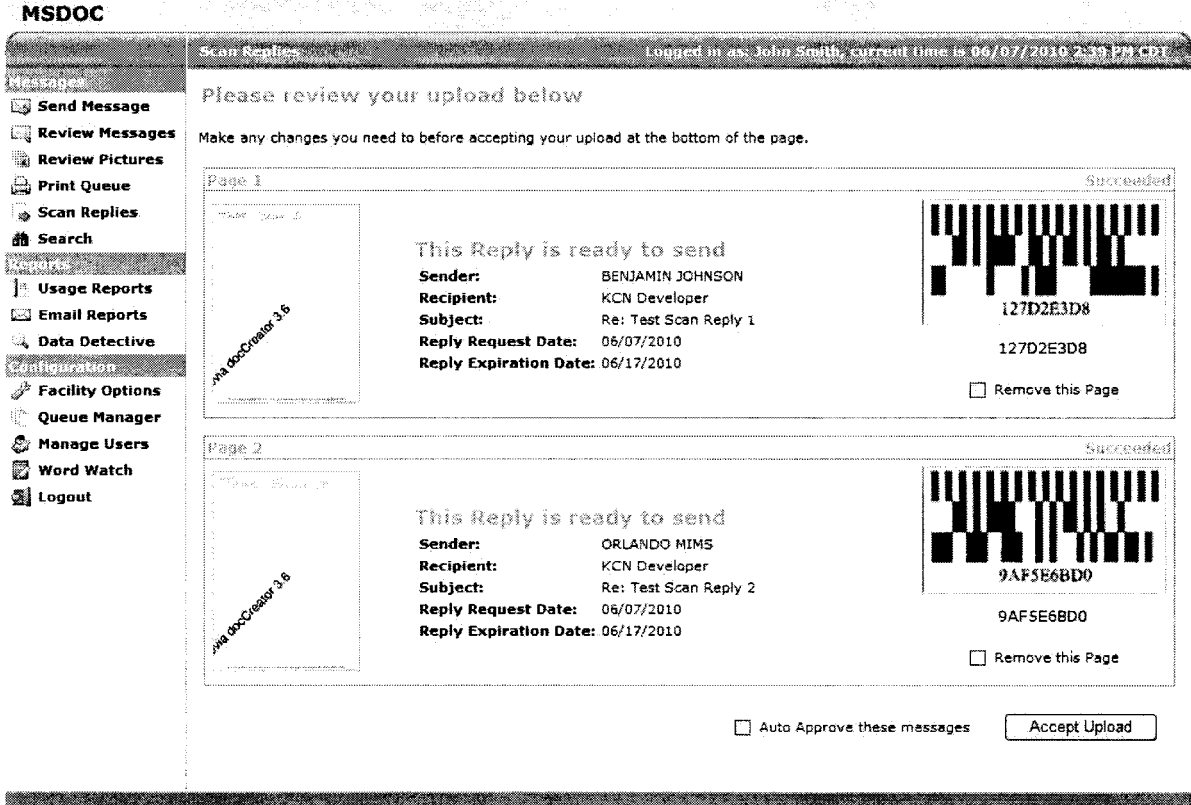

Delivery

Scanned messages are delivered to the appropriate message review queue based on the inmate’s location and escalation settings. Scanned messages will appear in the message review queue with a special scanned reply icon so that it is easily identified that it is a scanned reply. Reading the message displays the scanned image of the message. The staff can then review each message and decide whether it is approved or denied. They can also have the option to auto-approve each reply if the facility wants to use this option. Also, if the customer or inmate is flagged for auto-escalation, the message is automatically routed to the appropriate escalation queue instead. Once the message has been approved, it will then be delivered to the customer. When the customer views the message, they see a scanned image of the reply form. The Subject line will read: Re: Subject of Original Message.

Advantages

Keefe Group’s scan back reply message program has several advantages over other vendors. Keefe Group’s reply message program allows for multiple reply messages to be scanned all at once, while other vendor’s reply messages have to be scanned one at a time. Keefe Group’s reply messages each have a barcode on them which allows for the message to automatically route to the correct location and customer once uploaded to the facility management site. Unlike other vendors, where the facility will have to manually enter each reply page and corresponding code to identify the inmate and original sender of the message. Keefe Group’s is all done automatically using barcode technology.

Workstations

For areas where kiosk access may be restricted or unavailable, Keefe Group will also provide workstations and printers to place in facility mailrooms. Keefe Group will provide all hardware and software for these workstations at no cost to the Department. The workstations will include a Dell OptiPlex 780 desktop computer, monitor, keyboard, and mouse. Each workstation will also have a higher functioning printer/scanner combo unit. Keefe Group will supply all paper and toner as well as the Multi-Function Printer/Scanner at no cost to the Department.

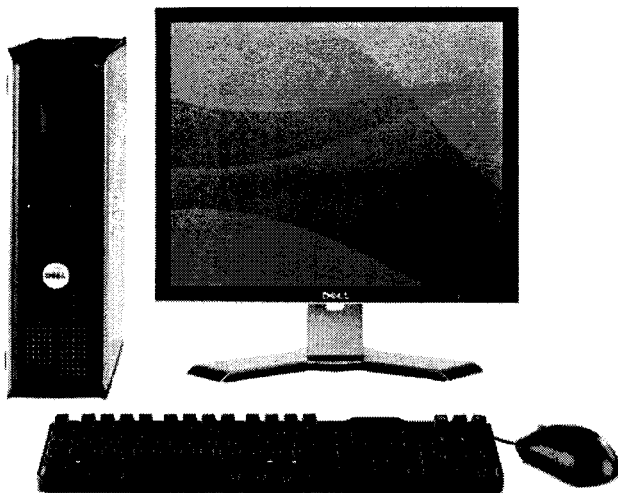

Computer Specifications

- OptiPlex 780 Desktop Base
- Dell Professional 17" Monitor
- OptiPlex 780 , Core 2 Duo E7500 with VT/2.93GHz
- 2GB, Non-ECC, 1333 MHz DDR3, 1x2GB
- Dell USB Entry Keyboard
- Dell MS111 USB Optical Mouse
- 250GB SATA 3.0Gb/s and 8MB Data Burst Cache, Dell OptiPlex 780

Keefe Group will provide the following:

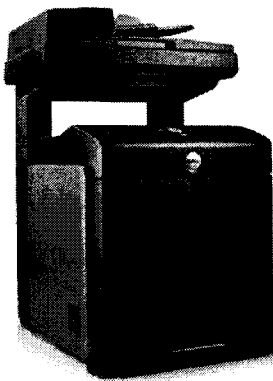

- **4-in-1 Design:** Combines quality color printing, faxing and scanning, with the ability to connect to a network or an individual PC.
- **Fast:** Prints up to 31 pages per minute in black and up to 17 pages per minute in color (actual print speeds will vary with use).
- **Robust:** Prints up to 60,000 pages per month (maximum duty cycle)
- **High Quality:** Produces professional-quality documents at up to 600 x 600 dpi (2400 image quality)
- **Flexible:** Features optional duplex (dual-sided) printing unit and optional second paper drawer

3.2.1.2 Inmate Banking – Many of the DOC's currently have a system to accept electronic funds transfers. If available, vendors shall provide their capability and system to provide Electronic Funds Transfer. The vendor must outline the process for verification via all methods, such as debit card, credit card, or money order.

NOTE: Vendors that accept credit cards must specify that they meet all card requirements for the processing of transactions. Nonpayment of credit card transactions will not be the responsibility of the DOC.

Online Deposits

In order to allow family and friends to make deposits online, Keefe Group operates a secure website 24/7/365. Depositors can visit our Secure Deposit website at www.inmatedeposits.com and setup an account. All that is required to set up an account is an email address and a personal password. This secure website is the same website as Keefe Group's Secure Mail™ program, so once an account is

created; the customer can use the same account for both Secure Mail and Secure Deposits. Once the user is logged into their account, they are in complete control.

Customers may view all previous transactions by Selecting Deposit Funds and clicking the yellow arrow by the inmate's name. This will show a complete transaction history for all deposits made to that inmate by that customer. Customers may not view any other transactions other than their own.

Phone Deposits

Keefe Group offers a toll free phone number for friends and family to deposit funds using their MasterCard or Visa debit/credit card into an inmate's account. Our bilingual Customer Service Representatives are available to take deposits 24 hours a day, 7 days a week.

Walk-In Cash Deposits

In order to provide Walk-In cash deposits to family and friends, Keefe Group has partnered with Western Union and Ace Cash Express for walk-in cash payment locations. These walk-in locations will accept cash deposits on behalf of the inmates. These walk-in locations make it simple and easy for family and friends to make deposits to an inmate's account. Western Union and Ace provide the most walk-in locations throughout the United States and worldwide.

Lobby Kiosk Deposits

Keefe Group has the largest network of lobby kiosks in the country servicing the Correctional market. We currently have over 220 lobby kiosks deployed in correctional facilities across the country. The kiosk will accept deposits via cash or credit/debit cards. Each kiosk also has the ability to take a photo of each depositor for potential investigative purposes.

Lock Box Service

Keefe Group can also provide a lock box service to collect money orders from friends and family to be deposited into an inmate's account. Keefe Group's proposed Lock Box collection will be maintained by Keefe Group staff. The process for collecting funds is simple and efficient. All funds delivered through this method are guaranteed by Keefe Group.

For Nevada, money orders will be processed from our Sparks, NV location. Being a local provider provides family and friends a quick and free option for posting money to an inmate's account. All money orders will be posted to the inmate's account within 24 hours of receipt.

Keefe Group has 16 distribution centers across the country, making it possible to process money orders from friends and family at a convenient, nearby location for many of the participating states, ensuring that the funds get transferred more quickly to the inmate's account.

Verification Features

Our current Approved Depositor feature will validate the depositor name provided against a customer supplied list of allowed depositors. Should the Department desire, this allows the Department to designate only certain individuals approved by the facility to make deposits to a particular inmate. This ensures the validity of those making deposits.

We also validate the house number and zip code of the address provided with the credit card company to also determine the validity of the depositor.

- 3.2.1.2.1 Exchange data with the DOC Inmate Banking System: including but not limited to bank balances and transaction information. Vendor to describe any limitations to the information can be presented to the inmate through the Kiosk.

Agreed - The Edge™ Inmate Self Service kiosk includes an Account Lookup feature that allows the inmate to review the transaction history of his/her custodial account. When the KeepTrak™ Inmate Banking system is used, this account history lookup operates in default mode without the need for an interface to a partner banking system. When connected to a partner banking system the account history display relies on an interface. Because of the requirements for timeliness in the presentation of financial information, the interface is most often a real time interface. The real time interface typically consists of a callable procedure provided by the partner banking system. The procedure input is the inmate identifier and the output is the line by line account history. Engineering for the real time interface is subject to design, development and testing estimates pertinent to the partner system.

Inmate information provided from the State DOC Offender Management System is used for validation of the Inmate account for which the deposit is to be applied. The Access Corrections web site, call center, and lobby kiosk applications each include lookup capabilities directly dependent upon the information provided by the State DOC Offender Management System. Display-able information includes offender first name, last name, ID, birth date, and housing location.

- 3.2.1.2.2 Kiosks installed in the visitation area shall be limited to deposits only and to include cash, checks, and credit cards.

Keefe Group has the largest network of lobby kiosks in the country servicing the Correctional market. We currently have over 220 lobby kiosks deployed in correctional facilities across the country. Keefe Group has technical support technicians who are responsible for the installation of our deposit kiosks. These technicians are employees of Keefe Group and have years of experience involved in technology implementation, including deposit kiosks. All deposit kiosks are shipped to our Corporate Headquarters where they are tested thoroughly before shipped to the customer location. Keefe Group technicians will install, configure and test the kiosk on-site. Furthermore, a designated technician will monitor each kiosk utilizing our management software. This management software sets Keefe Group apart from our competitors as it enables our staff to monitor each kiosk with alerts. Alerts we receive encompass all operations allowed by the kiosk. This guarantees that Keefe Group's deposit kiosks are managed as efficiently as possible. The kiosk will accept deposits via cash or credit/debit cards. **Each kiosk also has the ability to take a photo of each depositor for potential investigative purposes.**

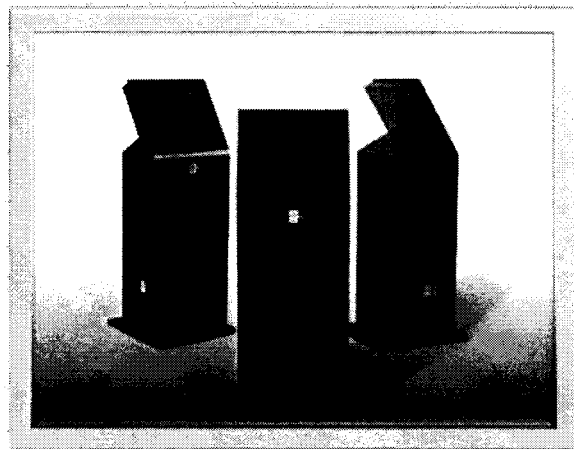

3.2.1.2.3 Enforce ability to maintain minimum and maximum deposit levels. Machine to have the ability to print deposit receipts.

Agreed – Kiosk does have the ability to maintain minimum and maximum deposit levels and also prints a deposit receipt upon the completion of the deposit.

3.2.1.2.4 Describe security features that insure accurate deposits, i.e., wrong account numbers.

Keefe has designed its Kiosk Deposit Services with multiple inmate verification points. The kiosk is able to display information approved by the State, including the Inmate Name, Inmate Master Number, date of birth, and inmate picture. The depositor must then verify at least twice that they are depositing to the correct inmate's account.

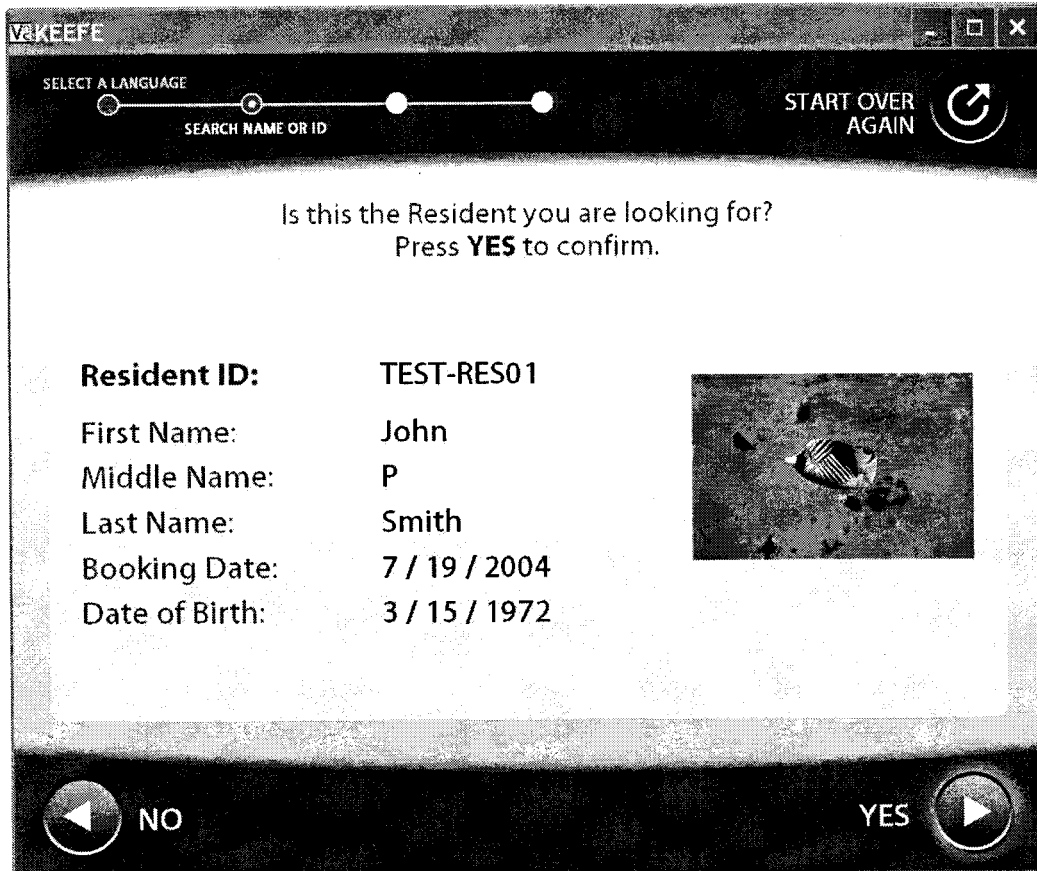

Keefe Group only has authorization to **deposit** funds in the County's designated bank account, not withdraw funds from inmate accounts. Because Keefe's system is real-time, funds are posted immediately to the inmate accounts. It is the depositor's responsibility to verify that they are depositing funds into the correct inmate's account

ACCESSCORRECTIONS® Deposit Services Interface

When Keefe Group's Deposit Services are used in conjunction with the KeepTrak™ ® Inmate Banking System the interface relies on secure IP network connections between the Agency network and Keefe Group's Centrally Managed Service Oriented Infrastructure. Keefe Group also publishes interface specifications to allow partner Inmate Banking systems to provide inmate lookup information for on-line depositors and to provide deposit posting capabilities for the partner Inmate Banking system.

- 3.2.1.2.5 Security - Provide the method of insuring inmate ID security. Vendors to provide their ability to provide biometrics, magnetic card readers, or other forms of security.

Keefe's Edge™ Kiosks can be fitted with fingerprint identification systems, ID card scanners, and wristband scanners. Keefe's Music Manager™ kiosk solution authenticates the media player not the inmate. The unique player sync and control application is centrally managed with fraud and theft controls. Keefe's Secure Deposits™ lobby kiosk authenticates a card-holder using standard credit processing protocols and OFAC checking. Cash depositors are identified by name. Participating States DOC may also supply approved depositor data for verification at the Secure Deposits™ lobby kiosk.

- 3.2.1.3 Inmate Grievances - (Internal complaint routing)
Vendor to provide internal document routing between inmate kiosk and DOC staff. If this currently does not exist, is there potential for future expansion in this area?

Keefe has an existing inmate grievance option, and two new Kiosk modules for inmate communications under development with expected availability later this year.

1. The first module allows the Participating State DOC to create forms of various types to be displayed at the Kiosk and completed by the inmate, then reviewed and routed by facility staff. The forms module is a paperless forms collection capability and assumes that the form is routed for actions / responses that are not expected to be delivered back to the kiosk.
2. The second module allows for two-way communication between Participating State DOC staff and the inmate in a request / response format. Each request and response is time-stamped, and the Participating State DOC may establish any number of request types for categorization of the communication.

- 3.2.1.4 Ability to Translate Information
- Spanish/English-English/Spanish;
 - Translate Applications/Information from English to other languages.

Each of Keefe Group's kiosk solutions have the option to be viewed in English or Spanish. Examples have been included on the next pages.

Edge Ordering Kiosk modules



Edge ordering Kiosk login screen

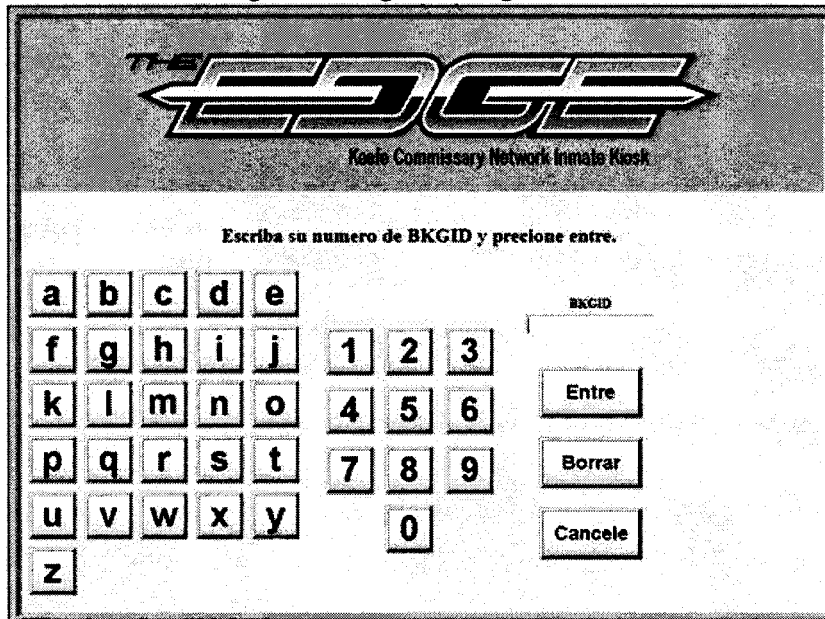

Deposit Services kiosk login screen

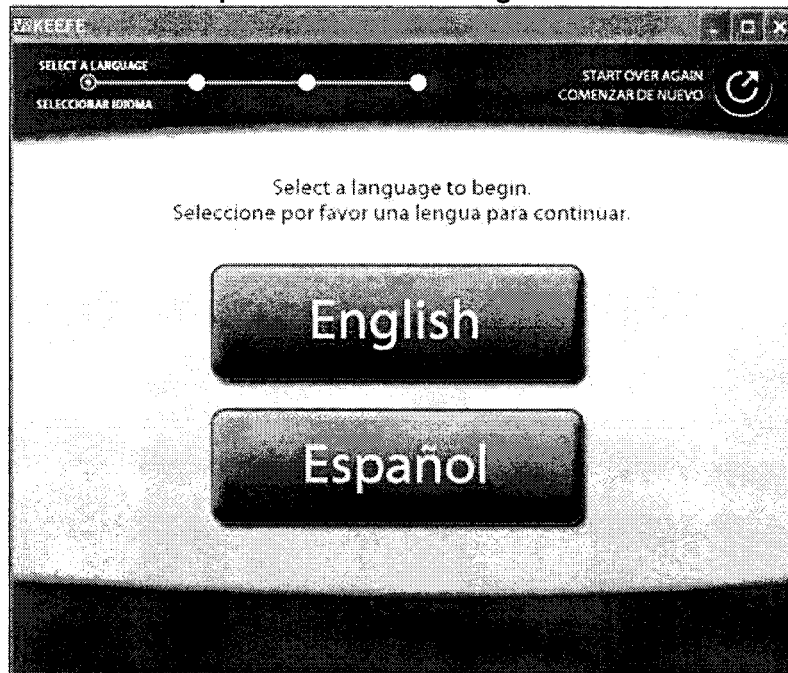

Additionally, Secure Mail customers also have the option of typing their message in English or Spanish. If they choose to write their message in Spanish, when the message is viewed in the Review Messages queue on the Facility website a translation of the message will be displayed along with the original message.

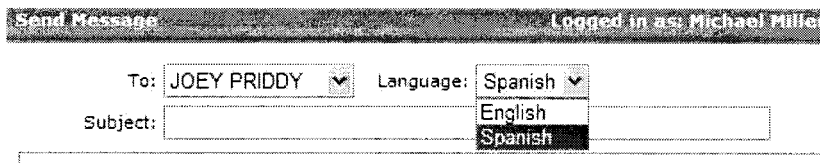

Here is a sample screenshot of the Spanish Translation review screen that will be available to the facility on the facility website. Not only will the message be translated but it will also still pass through Keefe Group's word watch software and highlight any flagged words, as seen below.

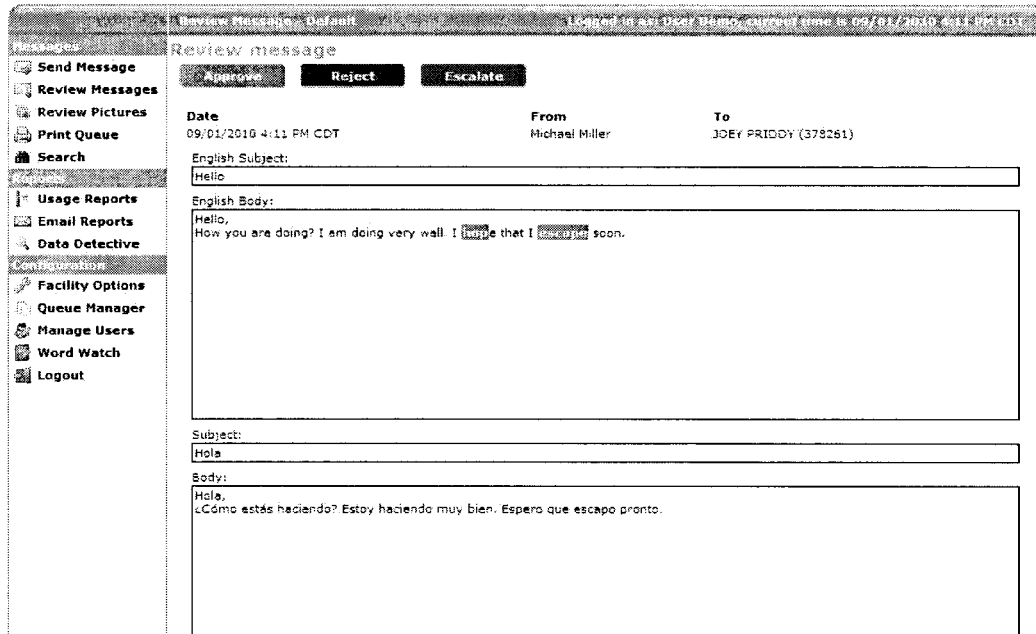

3.2.1.5 Inmates Commissary

3.2.1.5.1 Ordering commissary items directly through the kiosk.

Keefe's Edge™ Kiosk allows inmates to look up their accounts for balance and line item inquiries as well as order requests. The kiosk is designed to allow inmates to enter their orders and adjust them as often as they would like until the cutoff time. Once the cutoff time is reached, all order requests are processed and all facility rules are applied. After all requests are processed, orders are built and dispatched to the warehouse for fulfillment.

The Edge™ Kiosk has been built with the safety of the inmate and security of the facility in mind. All enclosures are solid surfaces and rounded at each point. The touch screen is made from shatter proof material, and the locks used are high security (tamperproof) vending machine locks. All systems are wall mounted and are easily converted to floor, stand-alone models.

Edge™ kiosks allow inmates to enter their facility number then their pin numbers, just as if they were at a bank ATM. The pin number is able to be reset by either the inmate or an authorized facility administrator. Inmates are able to identify themselves to the kiosk by either scanning a wrist band, a card or simple entering their facility number.

The application has the ability to allow the facility to configure multiple buttons to other functions. This can be used to do other things such as inmate requests/grievances, hair cut requests, policy and producers postings, and FAQ's by counselors, etc.

All kiosks are in English and Spanish and are very easy to understand.

3.2.1.5.2 Provide holiday or package program orders for the inmates.

Access SecurePak is the most comprehensive custom package program you will find in the correctional industry. Our program is centered on security, and offers you the flexibility and convenience you need. An affiliate of the Keefe Group, you will benefit from the market and product expertise we have been offering since 1975. In Nevada specifically, our successful program has been in place for 10 years. We are easily able to implement a custom package program for other participating states.

Why is SecurePak the choice for your custom package program?

- Product Expertise; product to meet the needs of the corrections industry...
- Security; our mission to you and the cornerstone behind our program...
- Customer Service; an approach designed to exceed your expectations...
- Flexibility; we adapt to fulfill the special needs for your program...
- Experience; in processing the volume of orders this program requires...
- Relationships; built on trust, integrity and mutual market knowledge...

Access SecurePak is the clear choice for your custom package solutions!

Access SecurePak custom package program is designed to eliminate contraband concerns, reduce the processing time of inmate packages, and help ensure a secure work environment within correctional facilities.

When designing a custom package program, you should consider:

- The safety of your officers.
- The safety of your inmates.
- The cost to process packages.
- The vendor's ability to deliver all specifications in a timely manner.
- The vendor's proven track record in implementing such a program correctional institutions.
- The vendor's ability to provide a variety of products packaged specifically for the correctional market.
- The benefits of a program that offers a complete turnkey operation.

How will SecurePak help ensure a secure environment?

- Orders are packaged in a secure environment, using a "blind" picking process created from our proprietary software package.
- Packages are sealed with a pre-printed tamper evident tape to ensure it has not been compromised by outside sources.
- All new employees undergo an extensive screening process and background checks.
- The program will eliminate the need to search and x-ray packages.
- The program will make property procedures more efficient and will increase overall safety within the facility

How does SecurePak work?

- The facility establishes all parameters:
 - How often and when inmates receive packages?
 - Who orders the packages; the family member or the inmate?
 - What products will be featured in the program?
 - What are the spending and/or weight limits?
- Access SecurePak creates approved catalogs, order forms, posters and other marketing pieces to display and distribute to the inmate population.
- Our acceptable payment methods include: institution check, money order and credit cards (Visa, MasterCard, and Discover).
- All orders are packed and shipped directly to the institution.

3.2.1.2.3 Interface purchases with the inmate banking system.

When KeepTrak™ ® Commissary is linked to a partner inmate banking system, the integration relies on the flow of Inmate identification, funds balance, housing and privilege level information from the OMS/JMS system to the KeepTrak™ ® Commissary system. In turn the KeepTrak™ ® Commissary system forwards inmate purchase and refund transaction information to the OMS/JMS inmate banking system.

3.2.1.6 Video Visitation

Our video visitation system is powered by Blackfin Technology, which is the first and most widely used internet video visitation system. Nearly 20,000 visits have been conducted using this system, which is live or currently being deployed in six states—including the Idaho Department of Corrections. The implementation of this video visitation system at the 1,000 bed Ada County Jail in Boise, ID, has been so successful that they have decided to entirely eliminate physical visitations on June 1, 2011. This system is fundamentally changing visitation.

No other system offers remote, web based visitation via both an on-demand or locally hosted basis. No similar system has been used as widely or extensively, and no other video visitation system has generated more revenue for facilities that operate it.

Our video visitation system has market leading technology, the lowest cost of deployment and the lowest total cost of ownership of any remote video visitation system.

Many studies have concluded that there is a tremendous benefit in the rehabilitation process when inmates have consistent interaction with their friends and family. There is even greater value for those inmates with dependency issues, and need direct interaction with friends and family to best prepare them for their release.

We bring a state-of-the-art solution to the DOC; one that will offer an efficient and practical program that will assist the DOC in the re-entry initiative and as an additional benefit, reduce costs, add security, reduce contraband entering facilities and is also an added revenue source to offset offender management.

Our Inmate Internet Visitation System enables visitation between inmates and people located anywhere in the world. The system includes software (hosted at an off-site, fully managed, and

secured facility) that handles visitation session scheduling, management of rules and workflows, session brokering and monitoring, and storage of inmate visitation session recordings for review by investigators. The hosted system can quickly be integrated with the DOC Offender Management System (OMS); onsite hardware requirements are minimal.

VIDEO VISITATION FUNCTIONALITY

The video visitation system implemented for the facility will include:

Visiting Station(s): Each visitation station is comprised of Keefe Group's proven Edge Kiosk with a built in camera, identification reader and jack for head-set..



Monitoring Stations: This system allows monitoring of video visitations from any computer with web access (no special hardware or software is required). The facility can control access to monitoring sessions through password and role assignment. We recommend the primary monitor station be located in a space where the guard has a clear line of sight to the inmate visitation stations.

The Monitoring Screen allows designated users (Monitors) to monitor the audio and video for each of the ongoing sessions. Monitors are able to terminate a session at any time by clicking a button on the screen labeled "Terminate Session".



ADA COUNTY JAIL VIDEO VISITATION



file: '_1032405.flv' @ 100%
video: (n/a) - audio: (n/a) - size: 320x240 (320x240)

A black and white video feed showing a close-up of a person's face, likely an inmate, looking towards the camera.

file: 'pbartlett77@gmail.com.flv' @ 100%
video: (n/a) - audio: (n/a) - size: 320x240 (320x240)



End Session

Web Based Scheduling: This system includes a web based scheduling system that enables inmates to invite visitors and schedule sessions. All visits are confirmed 24 hours in advance (to reduce no-shows and to facilitate processing of credit card payments while virtually eliminating credit card fraud). Visitor-initiated scheduling is currently in use today.

Scheduling can be integrated with the OMS and is based on facility defined policies. The system includes the ability to configure permissible visitations based on multiple facility defined parameters, for example, inmate, time of day, day of week, or visitor. Inmate visitation privileges can be curtailed or eliminated, visitors can be “black-listed” from the system, and visitation hours specified.



ADA COUNTY JAIL VIDEO VISITATION



DIRECTIONS

Step 1: Create an invitation:

- Go to INVITE SOMEONE to invite family or friends to be on your approved list of visitors.
- Follow the directions provided.
- To schedule visits, you must first create an approved list of visitors.

Step 2: Check the status of your invitation:

- Accepted invitations can be viewed by clicking on INVITE SOMEONE.
- Declined invitations will be sent to MESSAGES.

Step 3: If your family or friends have accepted your invitation, go to SCHEDULE SESSION and follow the directions provided.

RULE VIOLATIONS

Violating any of the following rules, directly or indirectly, could result in automatic termination of your visit and/or disciplinary action.

- Loud or disruptive conversations.
- Foul or threatening language.
- Sexual activity.
- Drug use.
- Directly or indirectly harassing any person.
- Violating or attempting to violate a no-contact or protection order.
- Using another inmates LE and Password.
- Attempting to bypass a blocked email address.
- Harassing or annoying outside parties by repeatedly sending unwanted visitor invitations.
- Illegal activity violating State, Local, or Federal law.



ADA COUNTY JAIL VIDEO VISITATION

HOME | SCHEDULE SESSION | INVITE SOMEONE | PROFESSIONAL VISITORS | MESSAGES | CHANGE PASSWORD

BlackfinVideo	
	Wednesday Thursday Friday Saturday Sunday Monday
8am	Reserve Time
	Reserve Time
9am	Reserve Time
	Reserve Time
10am	Reserve Time
	Reserve Time
11am	Reserve Time
	Reserve Time
12am	
1pm	Reserve Time
	Reserve Time
2pm	Reserve Time
	Reserve Time
3pm	Reserve Time
	Reserve Time
4pm	Reserve Time
	Reserve Time
5pm	
6pm	
7pm	Reserve Time
	Reserve Time
8pm	Reserve Time
	Reserve Time
9pm	Reserve Time
	Reserve Time
10pm	Reserve Time
	Reserve Time

DIRECTIONS

- Select a day
- Select a Station
- Select a time

INFORMATION

- Visits are a maximum of 25 minutes
- Visits begin on the hour and half hour (ex: 1:00, 1:30, 2:00, 2:30)
- Inmate is allowed a Maximum of 2 sessions



ADA COUNTY JAIL VIDEO VISITATION

HOME | SCHEDULE SESSION | INVITE SOMEONE | PROFESSIONAL VISITORS | MESSAGES | CHANGE PASSWORD

You are reserving

Station: BlackfinVideo
 Selected Day: Wednesday
 Starting At: 09:30 AM
 Guest: Chris Krasselt

Reserve Time Slot

Ada County Jail Video Visit invitation

donotreply@visit.adasheriff.org

Sent: Tue 11/2/2010 1:53 PM

To: Chris Krasselt

Jason Brooks3, an inmate in the Ada County Jail, has invited you to a Video Visit Session.

Please visit the following link for details.

<http://visit.adasheriff.org/IVVP.Guest/conference/Conference?authKey=78424947-83b4-49a9-8823-cd048366c389>

Jason Brooks3 un preso en la cárcel del condado de Ada, te ha invitado a una sesión de vídeo Visita.

Por favor, visite el siguiente enlace para más detalles.

<http://visit.adasheriff.org/IVVP.Guest/conference/Conference?authKey=78424947-83b4-49a9-8823-cd048366c389>



ADA COUNTY JAIL VIDEO VISITATION

Ada County Sheriff's Office | 7210 Barrister Drive Boise, ID | 208-577-3080

HOME | START SESSION | REQUIREMENTS | FAQ | HELP | ABOUT ACJVV | FORGOT PASSWORD? | CONTACT US

Jason Brooks3, an inmate in the Ada County Jail, has invited you to a Video Visit Session on Wednesday Nov 3 at 09:00 AM MDT.

This conference has already been funded. Accepting this request will not require further payment.



ADA COUNTY JAIL VIDEO VISITATION

Ada County Sheriff's Office | 7210 Barrister Drive Boise, ID | 208-577-3080

HOME | START SESSION | REQUIREMENTS | FAQ | HELP | ABOUT ACJVV | FORGOT PASSWORD? | CONTACT US

Your session has been scheduled. You can log in by visiting this site and selecting the "START SESSION" option from the main menu. The chat will automatically begin at your scheduled time.

Before your session we recommend that you go [here](#) and test your computer for compatibility with the video chat system. This test can be accessed at any time from the support section of our main site.

If you are a Clear Internet customer and are experiencing difficulties, click [HERE](#).



ADA COUNTY JAIL VIDEO VISITATION

BlackInVideo	
	Tuesday Wednesday Thursday Friday Saturday Sunday
8am	Block
	Block
	Jason Brooks and ckraseth@blackin.com (Confirmed) Cancel Session
9am	Block
	Block
10am	Block
	Block
11am	Block
	Block
12am	
1pm	Block
	Block
2pm	Block
	Block
3pm	Block
	Block
4pm	Block
	Block
5pm	
6pm	
7pm	Block
	Block
8pm	Block
	Block
9pm	Block
	Block
10pm	Block
	Block

Tracking inmate and end-user information: The system automatically logs inmate and visitor information and associates it with the visitation station. All visit data is stored in a database and is searchable via standard database queries.

OMS Interface: This system is designed with a web services layer to accommodate OMS interfaces. If desired, we will develop and implement an interface to the DOC's OMS, provided the OMS is able to output data in a defined format. We do not anticipate any problems designing and building this interface.

Recording and Recording Storage: All visitation sessions and data are typically stored for up to 90 days at the hosting facility. Visitations can be viewed by authorized DOC personnel via the web; any session can be downloaded for permanent storage.

Training: Required training for DOC employees and inmates will be simple and straightforward, live training will be provided at no charge. Training for visitors is handled via online web training resources.

3.2.1.6.1 Requirements for data transfer for video visitation.

Each concurrent video visitation session uses up to 256kbps of data transfer for highest quality video and audio. Total required data transfer can be calculated using the following formula $S * 256kbps * C\% = D$, where S = the number of visiting stations in the facility, C = the estimated percentage of stations to be used concurrently, and D = total data transfer required. C varies based on facility variables and the

number of visiting stations to be deployed but is generally less than 100% because full concurrent utilization of the system should (just as it is with telephones) be unusual, and over-provisioning of bandwidth can be costly. In instances where demand for data transfer exceeds available bandwidth, the System dynamically reduces video frame rate (temporarily reducing the quality of the video) to decrease bandwidth requirements to meet available bandwidth until the spike in concurrent utilization passes. Audio is not affected by this adjustment.

For this proposal, $S = 100$ and we estimate $C = 75\%$, thus the total required data transfer is 19MBPS.

3.2.1.6.2 Estimated impact of video visitation on the DOC network.

The scheduling and messaging traffic for our video visitation system should (for security reasons) be segregated from other DOC traffic. Two methods of segregation—via VLAN or physically separate network—are available. Keefe Group recommends the system be implemented on a physically separate network to avoid any consequences that may arise from high utilization and/or expansion of our system.

3.2.1.6.3 A plan for data lines should capabilities at the institutions be limited as a result of this implementation.

Our plan to segregate the scheduling and message traffic should limit the impact on data lines. Should capabilities become limited, Keefe Group will work with each Participating State to determine the best solution.

3.2.1.6.4 Vendor to propose recommended visitation time constraints.

Scheduling is integrated with the Facility JMS and is based on facility policies. The system includes the ability to configure permissible visitations based on multiple facility defined parameters, including, e.g. inmate, time of day, day of week, visitor, etc. Thus, inmate visitation privileges can be curtailed or eliminated, visitors can be “black-listed” from the system, visitation hours specified, etc.

Visitation length and charges can be set to any duration desired by the facility. We recommend:

- Visit length of 25 minutes
- Visitation hours 7am until lights out, excluding visitation during meals and inmate count times.
- Inmates should be limited to a maximum of three visits per day.

3.2.1.7 Inmate Scheduling

Vendor to provide any scheduling capabilities i.e. inmate medical appointment scheduling.

The Edge Kiosk features a personal calendar that allows inmates to communicate scheduled requests to facility services staff without the need for paper-based request systems.

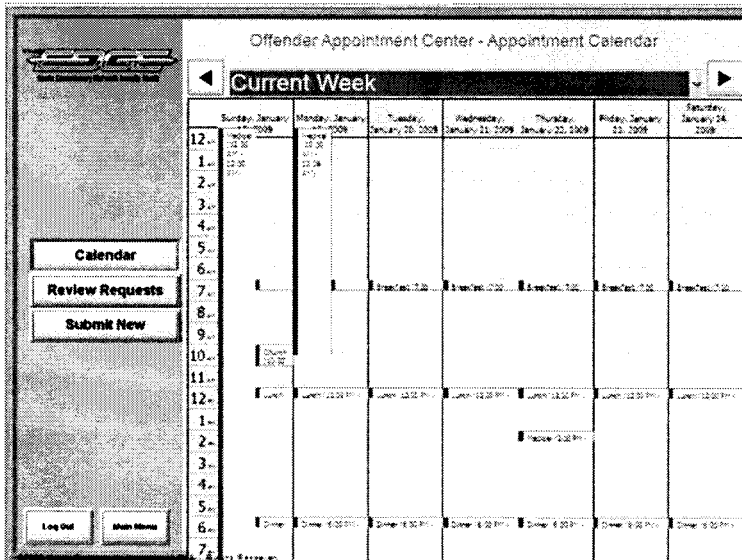

3.2.1.8 MP3 – Download / Purchasing of Music

Vendor must be able to customize music catalog for approval by institutions by State.

Agreed - The music library can be filtered to remove any content that is explicit. The content can be further filtered by album, artist and/or song at the facility's request. There is no limit to the control that can be exercised over the content made available through this program.

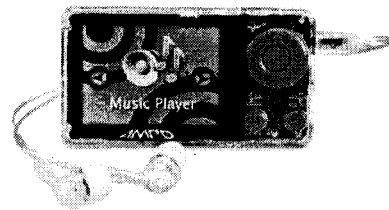

The Keefe Group MP3 Music Program provides a secure method by which users can browse, select and download digital content to their personal media player. The program consists of an Access MP3 portable media player, kiosks for downloading digital media and other content, and a private satellite delivery system. The MP3 music catalog is comprised of nearly 6 million individual songs and is one of the largest MP3 music catalogs in the country. In addition to music, this program also supports photos, email, educational content and rehabilitative programming. Our MP3 program runs on our own network and is the only proven correctional MP3 program currently operating in 8 state-wide DOC's with two additional awards currently launching. In addition, several other facilities, including BOP and ICE facilities, take advantage of our unique program which has delivered more than 2.5 million songs successfully to thousands of inmates.

3.2.1.8.1 Ability to download with and without direct access to the internet;

Keefe Group's delivery of music is via a completely private data network built specifically to support our program. The Network uses direct satellite communication to bypass public Internet, ensuring the highest level of security possible. It is not possible for users to reach the public Internet from this network. Nor is it possible to reach this network from the public Internet. The Network is composed of the latest technologies and is simply the most secure method by which to deliver content today.

3.2.1.8.2 Secure MP3 music downloads solutions;

Unlike other programs where inmates have to browse and select their music directly from the Kiosk, Keefe Group's MP3 program allows users to search for songs directly from his/her player. This process occurs during the users own time while in his/her cell. We have learned from studying our current customers that inmates spend 2 to 3 hours a day searching for songs. Programs that require inmates to search for, select and download music all while connected to a kiosk can present serious issues, including delays in receiving music and long lines forming as a result of the amount of time required per inmate. These lines can lead to disruption and/or disputes among the inmate population. With our MP3 program, a user simply selects the songs he/she wants to purchase directly from the player. The selected songs are then placed in the "Download Manager" on the player and will automatically download to the player upon the user's next connection to the kiosk. There is no direct access to the internet while downloading songs.

Keefe Group's delivery of music is via a completely private data network built specifically to support our program. The Network uses direct satellite communication to bypass public Internet, ensuring the highest level of security possible. It is not possible for users to reach the public Internet from this network. Nor is it possible to reach this network from the public Internet. The Network is composed of the latest technologies and is simply the most secure method by which to deliver content today.

Unlike other programs that require the use of the DOC's network to deliver music, Keefe Group's satellite network provides a separate network for the uplink to download music. This prevents critical bandwidth being taken up across the DOC's LAN and WAN. Keefe Group's program does not require the use of the DOC's WAN nor LAN to deliver music, thus making it the most efficient program available.

Plus over 70% of songs are stored directly at the kiosk allowing for the average download time of 8 seconds per song. By having the songs stored directly at the kiosk, Keefe Group's program operates much more efficiently. This process eliminates crowding and lines at the kiosk as well as considerably shortening the amount of time a user is connected. **The average connection time per user is less than three (3) minutes, and the average download time per song is 8 seconds.**

3.2.1.8.3 Offer a large variety of titles and genres available for purchase;

Keefe Group's music catalog consists of almost six (6) million individual tracks. The average size of a track is 4.2 MB. All tracks are provided in clear MP3 format. These tracks are provided without any digital rights management, which is an important and necessary component of successfully administering a correctional music program.

Keefe Group's catalog is composed of content from (a) the four major labels, which include Universal, Sony, EMI, and Warner, (b) several hundred private and/or specialty labels, and (c) thousands of independent artists via the Independent Online Distribution Alliance. In terms of the number of artists represented, the Keefe Group catalog is comparable in scope to major digital music retailers like Amazon and iTunes.

3.2.1.8.4 Alternative methods that allow the inmates to search and choose music (to place in a queue) without being connected to the kiosk. This includes the ability to choose order of preference and deleting selections in the queue;

Keefe Group's MP3 program allows users to search for songs directly from his/her player. This process occurs during the users own time while in his/her cell. We have learned from studying our current customers that inmates spend up to 2 to 3 hours a day searching for songs. Programs that require inmates to search for, select and download music all while connected to a kiosk can present serious issues, including delays in receiving music and long lines forming as a result of the amount of time required per inmate. These lines can lead to disruption and/or disputes among the inmate population. With our MP3 program, a user simply selects the songs he/she wants to purchase directly from the player. The selected songs are then placed in the "Download Manager" on the player. Once in the Download Manager the user will be able to remove and rearrange songs as often as they wish until they hook up to the kiosk to download and purchase the songs. Once connected to the kiosk, the songs in the Downlod Manager will automatically download to the player.

3.2.1.8.5 Download/data retrieval times;

Over 70% of songs are stored directly at the kiosk allowing for the average download time of 8 seconds per song. By having the songs stored directly at the kiosk, Keefe Group's program operates much more efficiently. This process eliminates crowding and lines at the kiosk as well as considerably shortening the amount of time a user is connected. The average connection time per user is less than three (3) minutes and the average download time per song is 8 seconds. If an ordered song is not stored directly at the kiosk, it will then be downloaded over our satellite network and will then be published and stored at all kiosks going forward.

Keefe Group has in place an automated process to restore media purchased by an inmate. Every time an inmate connects his player to the kiosk it will automatically check the current songs on his player against the songs he has previously purchased and add back to the player any song that is missing. The player will also automatically check for new updates to the catalog as well as new firmware updates for the player. This is a huge advantage as the facility and inmate will not have to do anything as it is all automated. The music catalog is updated daily.

- 3.2.1.8.6 Security features and if features can be disabled upon release for normal use. This includes any locking features to prevent music sharing, etc. Vendor to describe theft prevention features;

Security Features

Control: Player Mortality

Player Mortality is a key security feature of this program that forces each player to connect to the Kiosk at least once every 30 days. The Player will disable itself if its Mortality expires and must be connected to the Kiosk to begin working again. The benefits of Mortality include:

- **Device Heartbeat:** Mortality allows us to take a heartbeat of every player at least once every 30 days. If a player misses two consecutive mortality check-in connections, we notify the facility so they can locate the device.
- **Fraud Lock:** If a device is stolen and reported as such, the device will stop working when the Mortality expires. If the theft is reported, we can FRAUD LOCK the device. When the thief tries to connect the device, we will notify the prison of the time, date and kiosk location of where the player was detected. A device that has been fraud locked will remain unusable until the facility unlocks it.
- **Update Music Catalog:** The Mortality feature is a good way to ensure that the user always has a current copy of the music catalog on their device.

Player Only Connects to Kiosk

The Player will only communicate with our Edge Kiosk. The player will immediately turn off and freeze if it is connected to any computer other than our Edge Kiosk.

No Player-to-Player Communication

The players do not communicate with each other in any way. It is not possible for songs to be shared between devices or with any computer while in prison.

No External Storage Supported

The player does not support any form of external storage (SD, MicroSD, etc.), which means songs cannot be transferred off the players.

Private Satellite Network - No Internet Access

To ensure the highest level of security possible, the network uses direct satellite communication to bypass the public Internet. It is not possible for a user to reach the public Internet from this network, and it is not possible to reach this network from the public Internet. This network is composed of the latest technologies and is simply the most secure method by which to deliver content today.

Kiosk Security

Music management on the Edge Kiosk is designed to be “self-serve” and should not require any oversight or assistance from the facility. Our Edge Kiosk has the following security features:

- (1) Inmate simply connects his player and the kiosk takes over. The inmate will never access a mouse, keyboard, or any of the equipment inside the kiosk.
- (2) Constructed of fully-welded, 14-gauge steel
- (3) Locks on all sides

Removal of Security Features

Keefe Group’s MP3 program allows for the inmate’s player to have the security features removed upon release. The inmate would need to send the player back to Keefe Group. For a fee the inmate can have the old software removed and new software put on. Keefe Group will then ship the player back to them. They will not lose any previously purchased music as it will all still be on the player when they receive it back. Once the player has been “unlocked” it can then function as any normal MP3 player and can be used on any computer. Songs can then be bought through any normal means (i.e. iTunes, Amazon, etc.).

3.2.1.8.7 Capabilities of the actual MP3 player to be used. Are there base/upgraded versions? What is the min/max gigabyte capacity?

Keefe Group offers both a 4GB player and an 8GB player, and will introduce a mini player and 16GB player in the coming months. In addition to music, the program also supports photos, e-messages, educational content and rehabilitative programming. Our MP3 player is designed specifically for use in the correctional environment. Inmates can search the entire music catalog by song, artist and genre directly on the player. Our player is also capable of allowing the inmate to receive both e-messages and photos through our Secure Mail™ program as well as letting the inmate respond to those messages directly from the player.

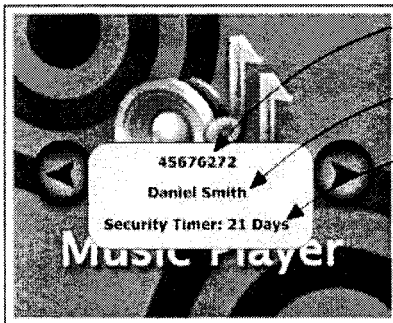
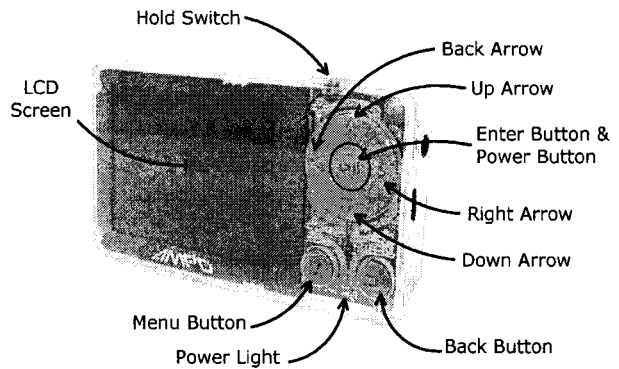

- Offender Number**
Displays the Offender Number of the device's registered owner.
- Owner Name**
Displays the Name of the device's registered owner.
- Security Timer**
Displays the number of days remaining until the device must be connected to the MusicWarden kiosk.

MP3 Program Overview

The Keefe Group MP3 Music Program provides a secure method by which users can browse, select and download digital content to their personal media player. The program consists of an Access MP3 portable media player, kiosks for downloading digital media and other content, and a private satellite delivery system. The MP3 music catalog is comprised of nearly 6 million individual songs and is one of the largest MP3 music catalogs in the country. In addition to music, this program also supports photos, email, educational content and rehabilitative programming. Our MP3 program runs on our own network and is the only proven correctional MP3 program currently operating in 8 state-wide DOC's with two additional awards currently launching. In addition, several other facilities, including BOP and ICE facilities, take advantage of our unique program which has delivered more than 2.5 million songs successfully to thousands of inmates.

Specifications - MP3 Portable Media Player:

- The Access MP3 Player is the only portable media player designed specifically for use in correctional environments.
- User name and number appears on the LCD screen each time the device is powered on for positive ID.
- Built from scratch, of heavy-duty clear plastic and shock-resistant hardware, with a host of specialized, correctional-only security features.
- Runs on AA batteries but allows for an AC adaptor to conserve battery life when an AC outlet is available.
- Comes with ear buds and batteries and has a permanently affixed serial number. The serial number is also programmed within the player.
- **While other programs require inmates to stand at the kiosk to make music selections, inmates search our music catalog by song, artist and genre directly on the player.** Based upon our studies, this feature consumes approximately 2 to 3 hours a day of inmate downtime while browsing our catalog.

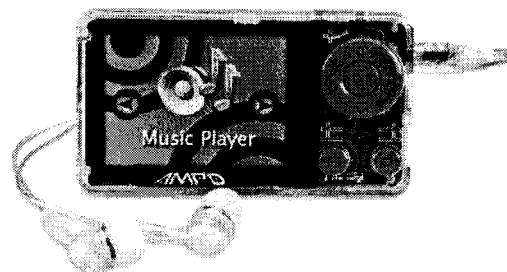

Music Management on the Edge Kiosk:

- When ready to download, users connect their player to the Edge Kiosk via a standard USB connection and the system automatically begins to download music.
- The Edge kiosk is designed to be "self-service" and does not require direct supervision by facility staff.
- Average connection time to the kiosk is less than three (3) minutes.
- Our proven kiosk system results in an efficient process that eliminates lines and problematic crowding associated with searching and downloading directly at the kiosk.

Music management on the Edge Kiosk

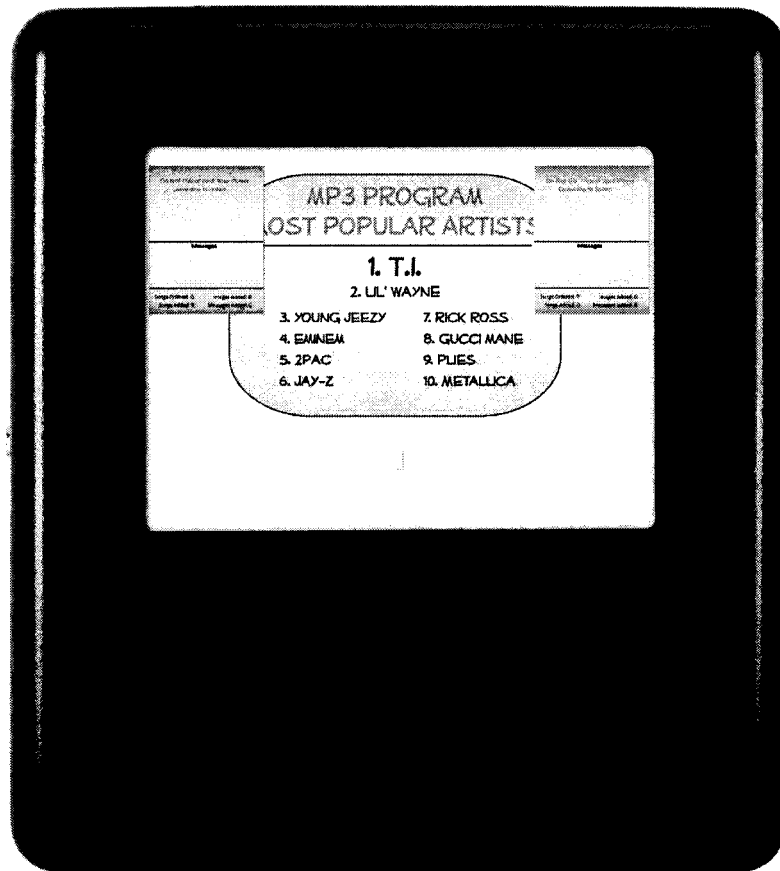

Private Satellite Network:

- Completely private data network built specifically to support our program.
- Network uses direct satellite communication to bypass public Internet, ensuring the highest level of security possible.
- It is not possible for users to reach the public Internet from this network. Nor is it possible to reach this network from the public Internet.
- Network is composed of the latest technologies and is simply the most secure method by which to deliver content today.

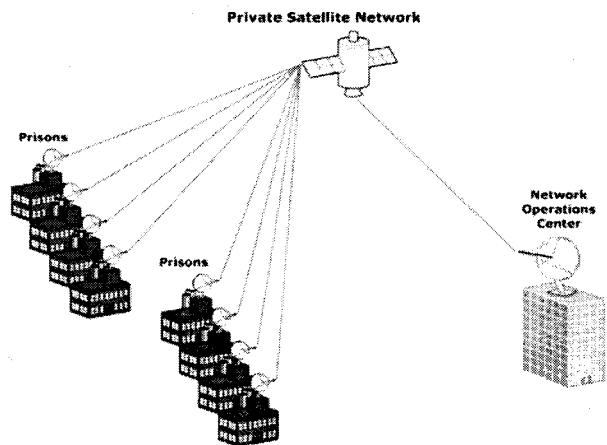

Accessories

External Keyboard

The Maxx Keyboard provides inmates a way to respond to approved messages directly on the player. It is made from durable clear rubber material and rolls up for easy storage and transport.

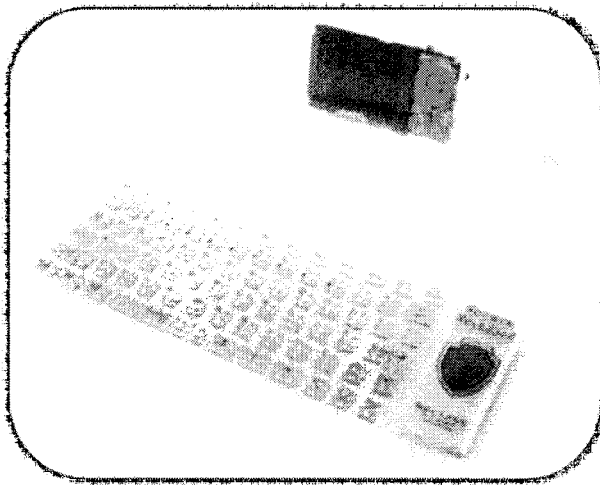

Music Catalog:

Keefe Group's music catalog consists of almost six (6) million individual tracks. The average size of a track is 4.2 MB. All tracks are provided in clear MP3 format. These tracks are provided without any digital rights management, which is an important and necessary component of successfully administering a correctional music program.

Keefe Group's catalog is composed of content from (a) the four major labels, which include Universal, Sony, EMI, and Warner, (b) several hundred private and/or specialty labels, and (c) thousands of independent artists via the Independent Online Distribution Alliance. In terms of the number of artists represented, the Keefe Group catalog is comparable in scope to major digital music retailers like Amazon and iTunes.

Keefe Group has in place an automated process to restore media purchased by an inmate. Every time an inmate connects his player to the kiosk it will automatically check the current songs on his player against the songs he has previously purchased and add back to the player any song that is missing. The player will also automatically check for new updates to the catalog as well as new firmware updates for the player. This is a huge advantage as the facility and inmate will not have to do anything as it is all automated. The music catalog is updated daily.

Upon the DOC's request, the music catalog can be filtered to eliminate any songs that have parental advisory or explicit lyrics or any other titles deemed inappropriate by the DOC.

Music Download - Search for Songs Directly on the Player:

Unlike other programs where inmates have to browse and select their music directly from the Kiosk, Keefe Group's MP3 program allows users to search for songs directly from his/her player. This process occurs during the users own time while in his/her cell. We have learned from studying our current

customers that inmates spend 2 to 3 hours a day searching for songs. Programs that require inmates to search for, select and download music all while connected to a kiosk can present serious issues, including delays in receiving music and long lines forming as a result of the amount of time required per inmate. These lines can lead to disruption and/or disputes among the inmate population. With our MP3 program, a user simply selects the songs he/she wants to purchase directly from the player. The selected songs are then placed in the "Download Manager" on the player and will automatically download to the player upon the user's next connection to the kiosk.

Transmitting of Songs to the Kiosk

Keefe Group's delivery of music is via a completely private data network built specifically to support our program. The Network uses direct satellite communication to bypass public Internet, ensuring the highest level of security possible. It is not possible for users to reach the public Internet from this network. Nor is it possible to reach this network from the public Internet. The Network is composed of the latest technologies and is simply the most secure method by which to deliver content today.

Unlike other programs that require the use of the DOC's network to deliver music, Keefe Group's satellite network provides a separate network for the uplink to download music. This prevents critical bandwidth being taken up across the DOC's WAN. Keefe Group's program does not require the use of the DOC's WAN to deliver music, thus making it the most efficient program available.

Plus over 70% of songs are stored directly at the kiosk allowing for the average download time of 8 seconds per song. By having the songs stored directly at the kiosk, Keefe Group's program operates much more efficiently. This process eliminates crowding and lines at the kiosk as well as considerably shortening the amount of time a user is connected. **The average connection time per user is less than three (3) minutes and the average download time per song is 8 seconds.**

How Offenders Pay for Downloaded Music

Keefe Group has a separate account for media purchases. An inmate can request to add funds from his/her trust account into his/her prepaid media account. Before downloading the songs to the inmate's player our kiosk checks the inmate's prepaid media account balance on our system to ensure the inmate has sufficient funds to purchase the requested songs. After songs are downloaded, the inmate then receives a message on their player stating their transaction history as well as their account balance.

Manufacturer's Warranty

Keefe Group's MP3 player was built to withstand the rigors of the correctional environment. However, we do provide a 60 day warranty against manufacturer defects. Keefe Group will provide shipping labels at no cost to allow the inmates to ship back their player's to either be fixed or replaced (if within the warranty period). Keefe Group will make an effort to get any player working even if it is outside the warranty period. However, some players are damaged too badly to be fixed.

Security Features

Player Only Connects to Kiosk

The Maxx Player will only communicate with our Edge Kiosk. The player will immediately turn off and freeze if it is connected to any computer other than our Edge Kiosk.

No Player-to-Player Communication

The players do not communicate with each other in any way. It is not possible for songs to be shared between devices or with any computer while in prison.

No External Storage Supported

The player does not support any form of external storage (SD, MicroSD, etc.), which means songs cannot be transferred off the players.

Private Satellite Network - No Internet Access

To ensure the highest level of security possible, the network uses direct satellite communication to bypass the public Internet. It is not possible for a user to reach the public Internet from this network, and it is not possible to reach this network from the public Internet. This network is composed of the latest technologies and is simply the most secure method by which to deliver content today.

Kiosk Security

Music management on the Edge Kiosk is designed to be “self-serve” and should not require any oversight or assistance from the facility. Our Edge Kiosk has the following security features:

- (1) Inmate simply connects his player and the kiosk takes over. The inmate will never access a mouse, keyboard, or any of the equipment inside the kiosk.
- (2) Constructed of fully-welded, 14-gauge steel
- (3) Locks on all sides

The User Experience:

This program has been developed to accommodate the security, control and logistical efficiencies required of content distribution within the correctional context. To accommodate the wide range of literacy levels and differences in technical familiarity among this user base, the process of selecting and ordering music has been organized into 3 easy and highly-secure steps:

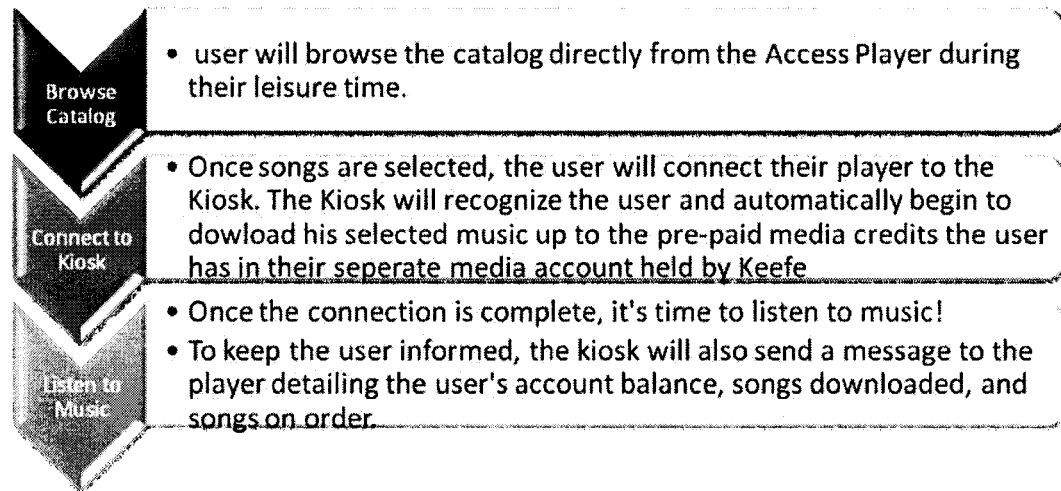

Program Benefits:

Information Screen: Positive Owner Identification

- The Information Screen displays the offender name and number on the Player's screen each time the device is powered on or when the menu button is held for three seconds.
- The Information Screen eliminates the need to etch or externally mark the property.
- This corrections-specific security feature reduces theft and allows correctional staff to easily manage the devices.

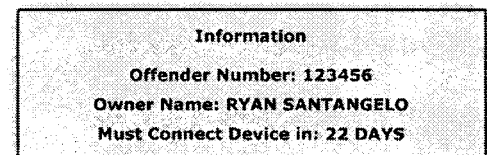

Reduced Property and Contraband

- The program significantly reduces property levels vs. other music programs.
- The program reduces the facility's costs associated with ordering and managing radios, cassettes, or CDs.
- The MP3 Player has no rotating motors or moving parts that can be used to make tattoo guns.

Music Library: Filtering and Control

- The music library can be filtered to remove any content that is explicit. The content can be further filtered by album, artist and/or song at the facility's request. There is no limit to the control that can be exercised over the content made available through this program.
- The music catalog is updated with newly released content on a daily basis.

Easy for the Facility to Manage

- The program is designed to be self-service and requires virtually no interaction by facility personnel.

Generation 3 MP3 Players

Mini Maxx Player

To provide inmates with a low cost player option, we have designed our Mini Maxx player. This player has all the same security features as the standard Maxx MP3 Player and will still be able to search for songs on the player; however, it would not be able to use the Secure Mail and Photo features.

Android Platform

Keefe Group is in current development for an advanced MP3 player. The advanced media player will include a number of new Self-Service features and share a number of Self-Service features otherwise available on the inmate pod Edge™ Kiosk platform. By enabling mobility of self-service features through its advanced media players Keefe Group minimizes the kiosk infrastructure burden to the Department. Advanced players will operate in off-line mode until synced either at an Edge™ Kiosk, Media Manager Kiosk or a Department endpoint equipped with Keefe Group-Sync software.

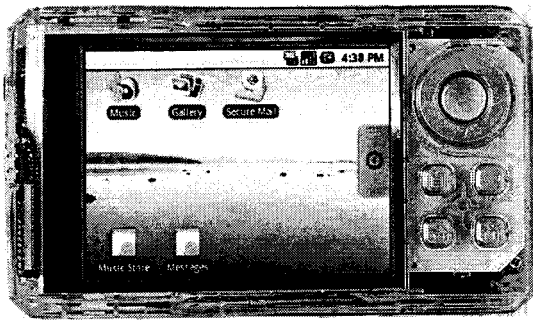

MAXXtouch

MAXXslide

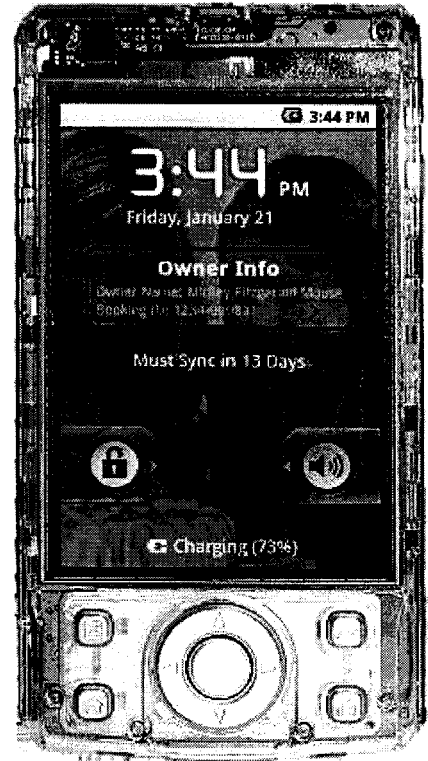

The above advanced players will offer an Android device manager platform which is more efficient and improved from the firmware style devices that are being offered today.

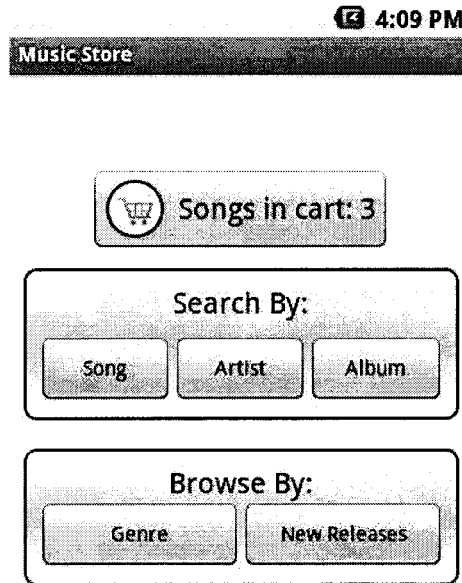
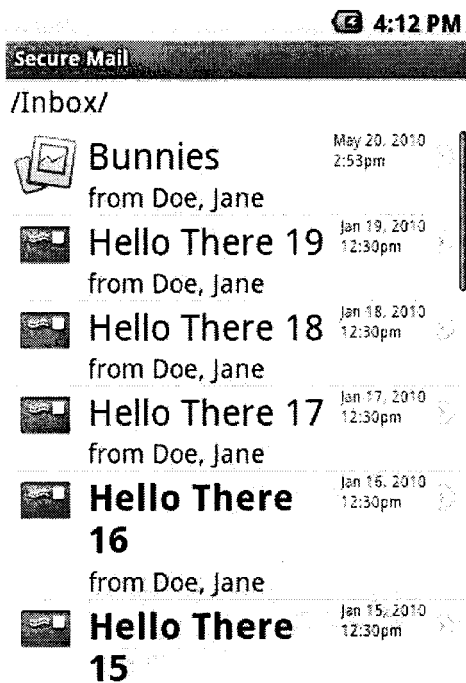

Advantages of the Android Based Device

Firmware based device software are generally fixed purpose requiring significant effort for modifications or enhancement. Enhancing a firmware based system is further complicated by the limited resources that can perform the enhancements. Since the device manager and applications are the same body of software and built using specialized chip level development environments a typical developer will not know how to program the firmware. Android based device software provides the core device management capabilities like a firmware based system would but it also supports the addition and provides tools to manage applications that are separate from the device managing software. This allows for an application or enhancement to be developed with no changes to the core device management software. Since these applications are written using standard toolsets there is a much wider developer pool to write applications for the device allowing for quicker turnaround on new features and a longer useful life for the device.

Firmware is developed specifically for the chips for that specific device and as such migration from one model to the next brings significant costs and risks to stability. Since firmware based device software is very tightly tied to the hardware itself there are very small or in some cases no technology eco system supporting the technology.

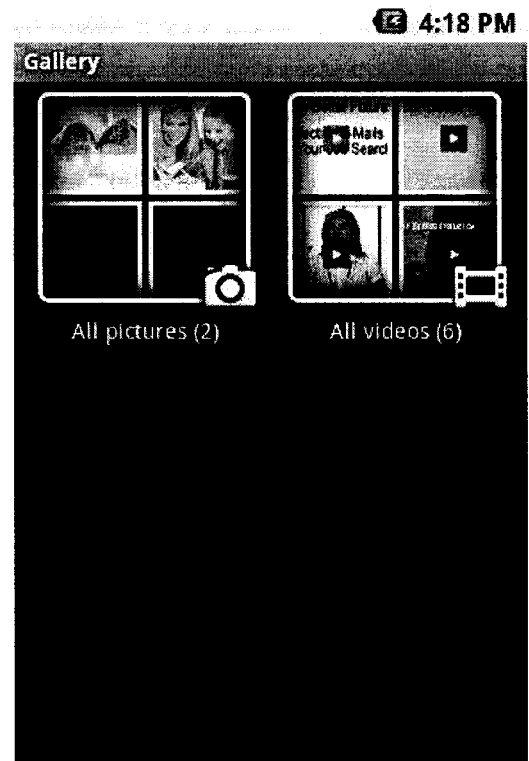

Android based device software includes software drivers for the chip level components but the core of the system is consistent across devices. This leads to predictable and smooth transitions from one model to the next. Since there are a number of devices built using the same base platform there is a rich technology eco system supporting the core technology. This leads to stability and advanced features that would just not be possible in a firmware environment.

We have selected to go with an Android based device platform to gain all the rich advantages indicated above. We are further modifying the core android to provide the enhanced security and usability items necessary for inmate/facility use. We are not deploying the standard Android but a highly customized locked down version gaining all the benefits while provided all of the flexibility for the future.

This advanced player will have the capability to allow for the following features directly from the MP3 player:

- Music
- E-Messaging
- Photos
- Videos
- Games
- Education – CEA
- Commissary Ordering
- Facility Content

3.2.1.8.8 Describe power features and how recharging of the player is achieved;

Keefe Group's MP3 players run on two (2) AA batteries and do not have built in rechargeable batteries. Each MP3 player comes with 2 AA Ion Alkaline Batteries. Keefe Group also offers an AC adaptor as an accessory to the MP3 player. The AC adaptor allows for the player to conserve battery life by utilizing the AC adaptor power when an AC outlet is available.

3.2.1.8.9 Must be able to provide inmate with transaction data/account balance;

Agreed – After songs are downloaded, the inmate receives a message on their player displaying the songs they just purchased, their transaction history and their account balance.

3.2.1.8.10 System to be able to catalog inmate songs in a database; the ability for the inmate to manage his total music library;

Agreed – System stores a complete database of each inmate's song purchases. The inmate has the ability to manage his total music library. The player also has a "Re-Order Manager." This allows the inmate to own an unlimited amount of music. If they have purchased a lot of songs and no longer have room on their player for new songs, they can simply make room for new songs by deleting old songs. We will store all of their deleted songs at no cost and they will have the ability to re-download them whenever they want at no cost.

3.2.1.8.11 Player must be clear to provide viewing of internal components;

Agreed – The player was built from scratch specifically for the corrections environment. It is made of a heavy duty clear plastic that allows for viewing of internal components.

3.2.1.8.12 DOC must have the capability to approve all music available to purchase on the catalog; and

Agreed - The music library can be filtered to remove any content that is explicit. The content can be further filtered by album, artist and/or song at the facility's request. There is no limit to the control that can be exercised over the content made available through this program.

3.2.1.8.13 Vendor must have contractual rights to distribute digital media from major music labels or other entertainment fields to provide reasonable volume of acceptable media content.

Agreed - Keefe Group's catalog is composed of content from (a) the four major labels, which include Universal, Sony, EMI, and Warner, (b) several hundred private and/or specialty labels, and (c) thousands of independent artists via the Independent Online Distribution Alliance. In terms of the number of artists represented, the Keefe Group catalog is comparable in scope to major digital music retailers like Amazon and iTunes.

Keefe Group's music catalog consists of almost six (6) million individual tracks. The average size of a track is 4.2 MB. All tracks are provided in clear MP3 format. These tracks are provided without any digital rights management, which is an important and necessary component of successfully administering a correctional music program.

3.2.1.9 Phone Time Usage
Capabilities for the kiosk to provide tracking of phone time usage.

The Edge™ kiosk phone management feature allows the offender to browse both phone call history and call charge history. The feature also allows the offender to request the addition of personal allowed numbers (PAN) to his her caller list.

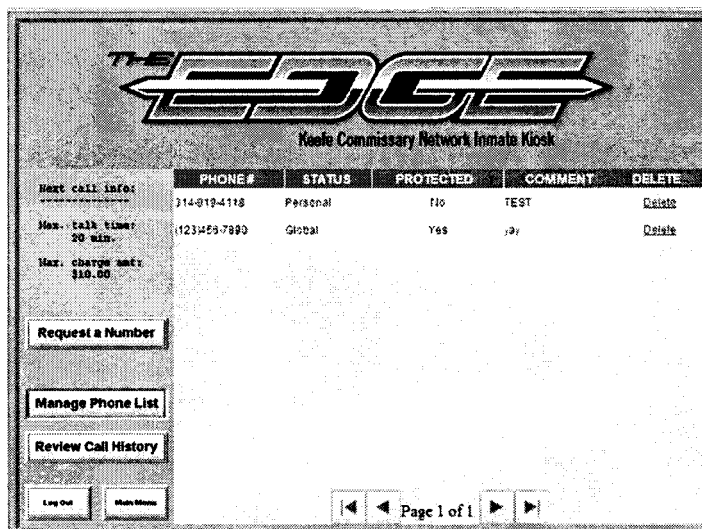

If Keefe’s inmate banking software is being used, we will request that the phone vendor provide an integration to implement Direct Link Trust (DLT) free of charge. DLT allows inmates to access their trust account to fund calling. We can also work with the phone vendor to provide phone-order entry. In Nevada, Wyoming and other states where IC Solutions is the inmate phone provider, IC Solutions has agreed to provide the necessary integration for phone order entry at no cost to the DOC. This option can be used for all inmates, but has direct benefits to inmates with limited movement. This method will continue to uphold all ordering restrictions, and inmates have the option of checking account balances and recent deposits. In Nevada, Wyoming, and any other states where ICS is the inmate phone provider, IC Solutions has agreed to provide the necessary integration for DLT at no cost to the DOC.

- KeepTrak™® IVR Phone Interfaces
 - The KeepTrak™® IVR commissary order entry system is attachable to facility inmate phone systems. The interface relies on network connections to a facility-based or centralized phone switch. The KeepTrak™® IVR commissary order entry system requires the KeepTrak™® Commissary Module and is seamlessly interfaced with the KeepTrak™® Inmate Banking System. If the facility is not using the KeepTrak™® Inmate Banking System, the KeepTrak™® IVR/Commissary solution can be interfaced with partner inmate banking systems.
- KeepTrak™® DirectDebit Inmate Real-Time Phone Interface
 - When the KeepTrak™® Inmate Banking System is used to charge inmate accounts for phone time as the call occurs, the interface relies on network connections to a facility-based or centralized phone switch.
- KeepTrak™® DirectSales Inmate Pre-Paid Phone Interface
 - When the KeepTrak™® Commissary System is used for charging inmate accounts for pre-paid phone time, the interface requires the phone vendor to connect to Keefe Group’s central managed services platform to transfer pre-paid phone charges to the phone system pre-paid inmate accounts.

- 3.2.1.10 Application Architecture
 - 3.2.1.10.1 Open source application.
 - 3.2.1.10.2 Documented Interface API and tool kit ad.
 - 3.2.1.10.3 Custom changes to the Interface API.

Access Corrections Secure Deposits Overview

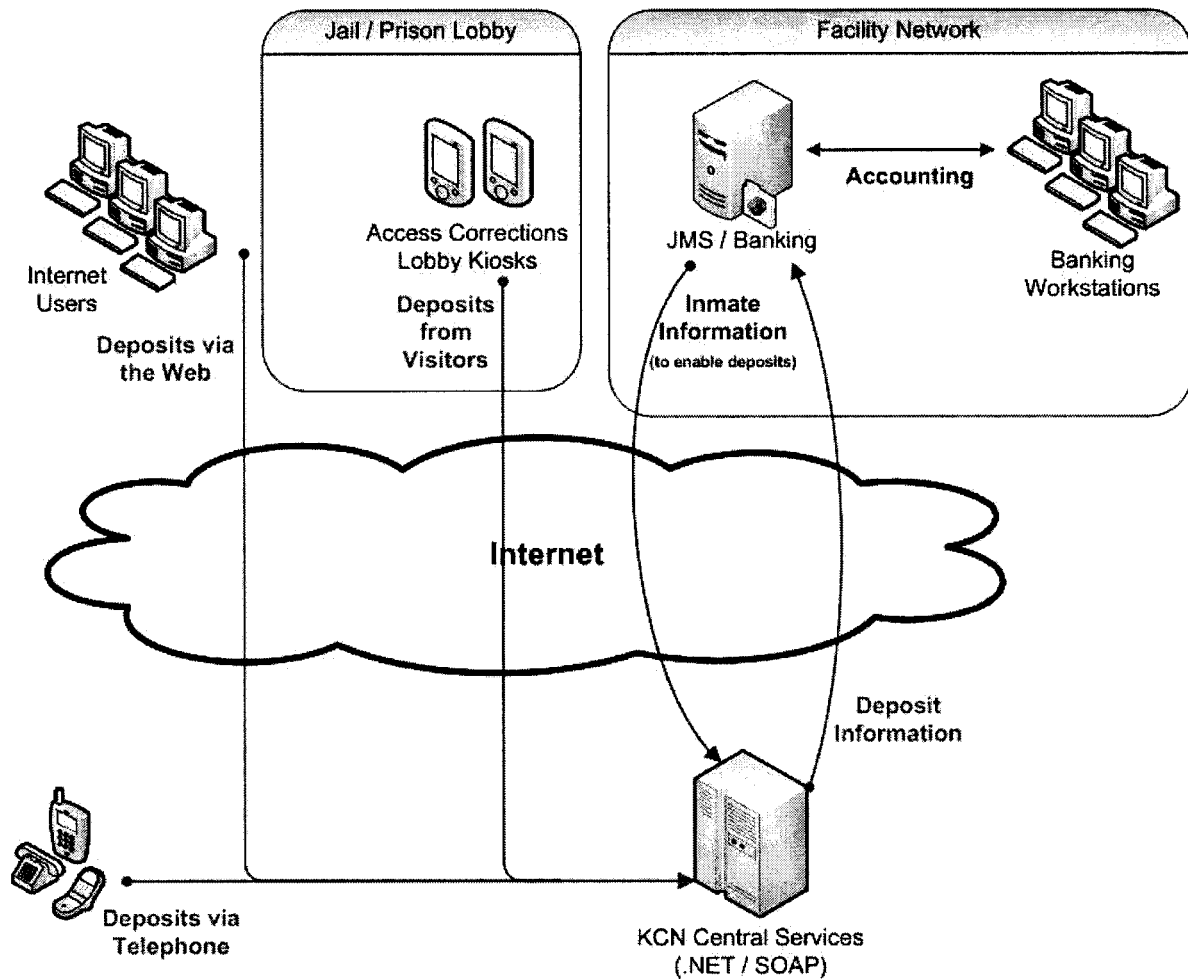

Layered Security

- The web application layer is segregated from Access Corrections database resources by the .NET SOAP architecture.
- Application level authentication is enabled at the source of each information flow and is managed centrally through Keefe Group administrative applications.
- User and application passwords are encrypted.
- HTTPS TLS-SSL encryption is enabled within each web application flow and SFTP is available for File Transfers to and from the DOC system.

Network Overview

Internet Connection Types for Information Sources

The kiosks will connect to the Keefe Group Central Services through a Keefe Group-provided internet connection either through EVDO (cell modem) technology or DSL. The connection from the JMS / Banking system for publication of inmate information and receipt of completed deposits may be either FTP-based (ports 20/21) or web services based (port 443) depending on the State's ability to interact via files or in real time.

AccessCorrections™ SecureDeposit™ Kiosks will be located in visitation areas at selected facilities:

1. AccessCorrections™ SecureDeposits™ Kiosks require no interaction with the network. The selected internet connection device connects to the only Ethernet port on the WIN XPe computer inside the kiosk. Wifi radio is disabled on the kiosk devices, eliminating the opportunity to create a sub-network resource from a single kiosk.
2. Keefe Group Server resources are protected by a hardware firewall DMZ. Requests to the web services hosted within the DMZ are managed by Keefe Group web services custom applications, for which Keefe Group creates, maintains and owns the source code.
3. Kiosks require 110 V power from a regular 20-amp AC circuit, and are equipped with UPS for temporary availability in the event of power outage.

The following diagram illustrates the on-premise architecture that coordinates with turnkey services provided by Keefe (assumes file-based EFT exchanges)

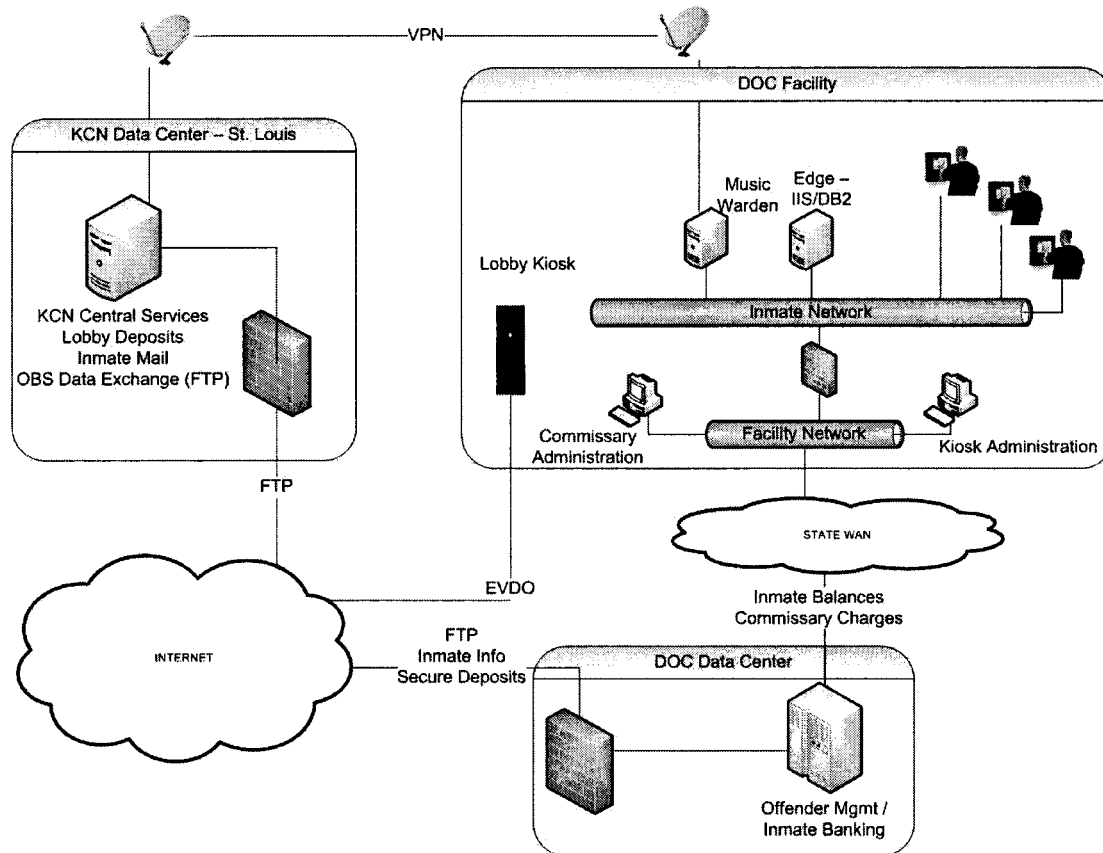

3.2.1.11 Interfacing

3.2.1.11.1 Vendor to detail their capability to interface vendor's applications to DOC applications.

Keefe Group Data Exchange Interfaces for KeepTrak™ ® and ACCESSCORRECTIONS®

- Keefe Group supports a variety of standardized KeepTrak™ ® and ACCESSCORRECTIONS® data exchange interfaces. These interfaces currently connect with more than 40 JMS/OMS company systems, dozens of State IT organization systems, and a variety of private Correctional Management systems. Although dynamic real-time interfaces are the preferred approach, Keefe Group also supports file-based batch-type interfaces when required.
- Keefe Group provides the development resources to create and support the interface code for its various KeepTrak™ ® and ACCESSCORRECTIONS® systems. Keefe Group also provides specifications to developers of partner systems for the creation and maintenance of their respective interface components in relation to Keefe Group's data exchange capabilities.
- Development costs for the KeepTrak™ ® and ACCESSCORRECTIONS® interface code created and maintained by Keefe Group software engineers are the responsibility of Keefe Group and represent no additional cost to the Agency. Because the Agency (State, BOP) is in the unique position of being both the customer of Keefe Group and of the partner JMS/OMS provider, the success of interface initiatives is accelerated when the Agency takes a primary role in steering the interface project.

Types of Data Exchange Interfaces Available from Keefe Group

The type of information needed for an interface will vary depending upon which functions of KeepTrak™® and ACCESSCORRECTIONS® the Agency plans on using.

- **KeepTrak™® Inmate Banking Integrations**
 - When KeepTrak™® Inmate Banking is used, the integration relies on read-only flows of Intake, Release, and Housing information from the OMS/JMS system to the KeepTrak™® Inmate Banking System. KeepTrak™® Inmate Banking may also be queried by the OMS/JMS for summary financial information through web-based interfaces built into the KeepTrak™® Inmate Banking System.
- **KeepTrak™® Commissary Integrations**
 - When KeepTrak™® Commissary is linked to a partner inmate banking system, the integration relies on the flow of Inmate identification, funds balance, housing and privilege level information from the OMS/JMS system to the KeepTrak™® Commissary system. In turn the KeepTrak™® Commissary system forwards inmate purchase and refund transaction information to the OMS/JMS inmate banking system.
- **KeepTrak™® Fulfillment Center Integrations**
 - When both the inmate banking and commissary systems are provided by a partner system, the integration relies on the flow of approved item by item detailed receipt information from the partner OMS/JMS commissary system to the Keefe Group warehouse.
- **ACCESSCORRECTIONS® Deposit Services Interface**
 - When ACCESSCORRECTIONS® Deposit Services are used in conjunction with the KeepTrak™® Inmate Banking System the interface relies on secure IP network connections between the Agency network and Keefe Group's Centrally Managed Service Oriented Infrastructure. Keefe Group also publishes interface specifications to allow partner Inmate Banking systems to provide inmate lookup information for on-line depositors and to provide deposit posting capabilities for the partner Inmate Banking system.
- **ACCESSCORRECTIONS® Release Services Interface**
 - When ACCESSCORRECTIONS® Release Services are used in conjunction with the KeepTrak™® Inmate Banking System the interface relies on secure IP network connections between the Agency network and Keefe Group's Centrally Managed Service Oriented Infrastructure. Keefe Group also publishes interface specifications to allow partner Inmate Banking systems to utilize Keefe Group's Centrally Managed Service Oriented Infrastructure to provide secure timely and accurate transaction processing for inmate account settlement within a partner inmate banking system.
- **KeepTrak™® IVR Phone Interfaces**
 - The KeepTrak™® IVR commissary order entry system is attachable to facility inmate phone systems. The interface relies on network connections to a facility-based or centralized phone switch. The KeepTrak™® IVR commissary order entry system requires the KeepTrak™® Commissary Module and is seamlessly interfaced with the KeepTrak™® Inmate Banking System. If the facility is not using the KeepTrak™® Inmate Banking System,

the KeepTrak™® IVR/Commissary solution can be interfaced with partner inmate banking systems.

- KeepTrak™® DirectDebit Inmate Real-Time Phone Interface
 - When the KeepTrak™® Inmate Banking System is used to charge inmate accounts for phone time as the call occurs, the interface relies on network connections to a facility-based or centralized phone switch.
- KeepTrak™® DirectSales Inmate Pre-Paid Phone Interface
 - When the KeepTrak™® Commissary System is used for charging inmate accounts for pre-paid phone time, the interface requires the phone vendor to connect to Keefe Group's central managed services platform to transfer pre-paid phone charges to the phone system pre-paid inmate accounts.

3.2.1.11.2 Security and capability when interfacing to DOC applications.

Access Corrections Secure Deposits Overview

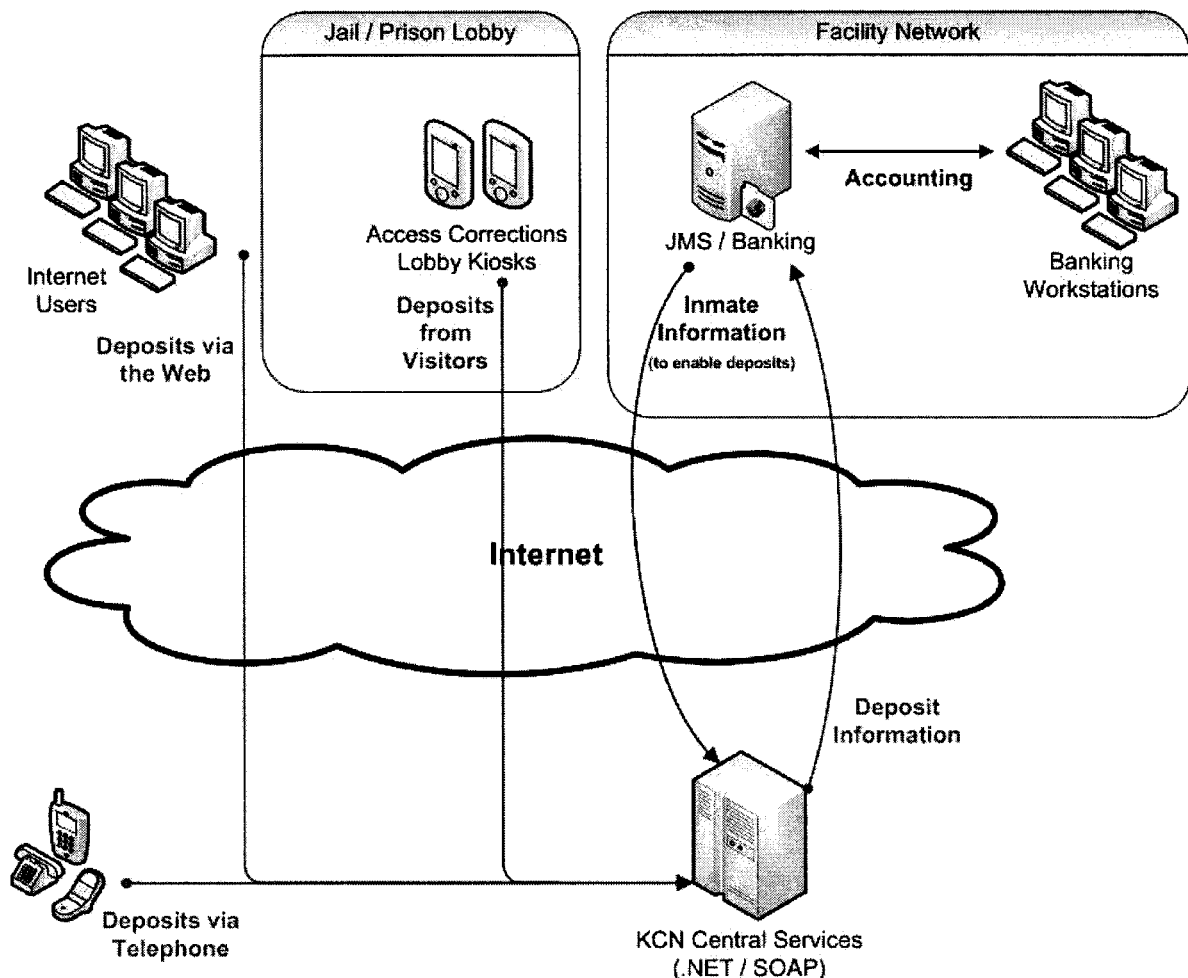

Layered Security

- The web application layer is segregated from Access Corrections database resources by the .NET SOAP architecture.
- Application level authentication is enabled at the source of each information flow and is managed centrally through Keefe Group administrative applications.
- User and application passwords are encrypted.
- HTTPS TLS-SSL encryption is enabled within each web application flow and SFTP is available for File Transfers to and from the DOC system.

Network Overview

Internet Connection Types for Information Sources

The kiosks will connect to the Keefe Group Central Services through a Keefe Group-provided internet connection either through EVDO (cell modem) technology or DSL. The connection from the JMS / Banking system for publication of inmate information and receipt of completed deposits may be either FTP-based (ports 20/21) or web services based (port 443) depending on the State's ability to interact via files or in real time.

AccessCorrections™ SecureDeposit™ Kiosks will be located in visitation areas at selected facilities:

4. AccessCorrections™ SecureDeposits™ Kiosks require no interaction with the state network. The selected internet connection device connects to the only Ethernet port on the WIN XPe computer inside the kiosk. Wifi radio is disabled on the kiosk devices, eliminating the opportunity to create a sub-network resource from a single kiosk.
5. Keefe Group Server resources are protected by a hardware firewall DMZ. Requests to the web services hosted within the DMZ are managed by Keefe Group web services custom applications, for which Keefe Group creates, maintains and owns the source code.
6. Kiosks require 110 V power from a regular 20-amp AC circuit, and are equipped with UPS for temporary availability in the event of power outage.

The following diagram illustrates the on-premise architecture that coordinates with turnkey services provided by Keefe (assumes file-based EFT exchanges)

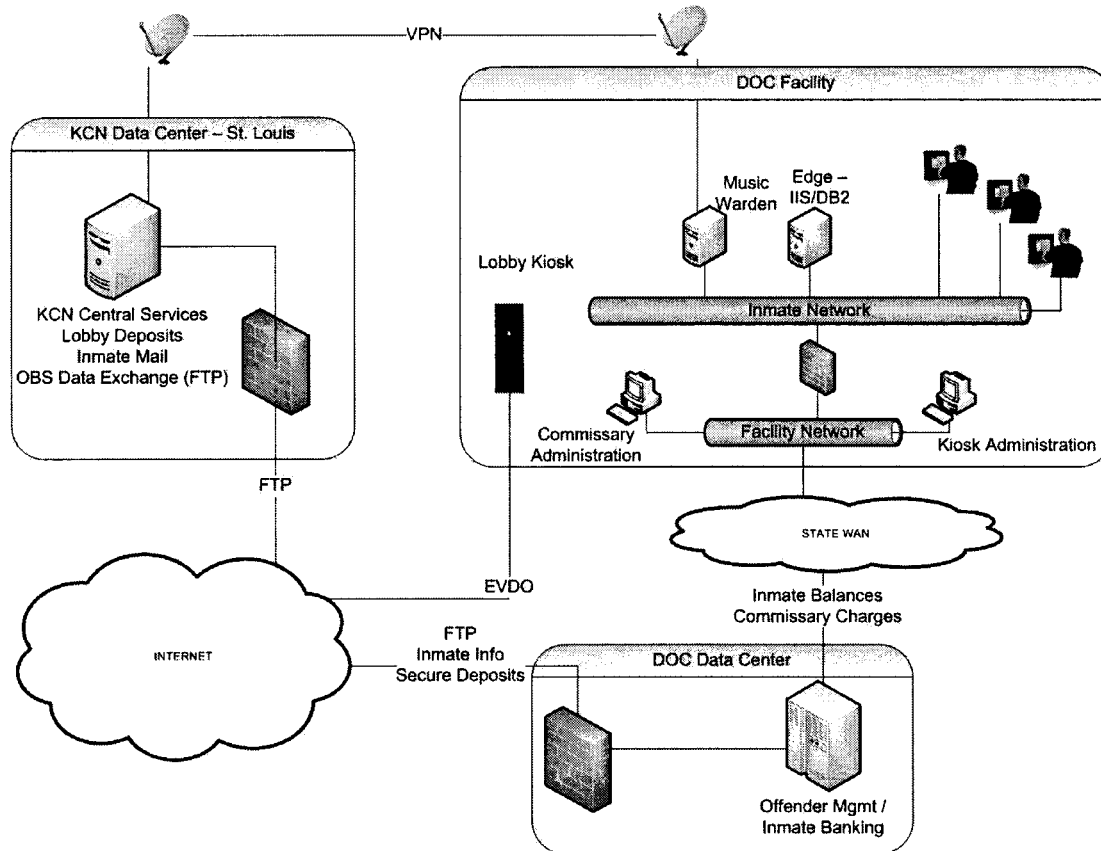

3.2.1.12 Communications

Kiosks to support communications via:

- Cable
- Wireless
- DSL
- Other

Agreed – Keefe’s kiosk solutions are consistent with this requirement.

3.2.1.13 Scalability

Vendor to recommend number of inmate to kiosk ratio and how their system can adjust based on changing inmate populations. Provide all assumptions used to identify required computing power and/or hardware.

Since 2005, Keefe has deployed over 950 kiosks in more than 80 correctional agencies. From that experience we have determined that a single kiosk can adequately service 100 inmates.

3.2.2 Software Requirements

The successful vendor shall provide a kiosk application that will run on an operating system designated by the DOC and is capable of being upgraded.

Agreed - Keefe's kiosk systems run on Windows and Windows embedded operating systems.

The successful vendor shall allow for additional applications to be added as determined necessary by the DOC. Upon mutual agreement between the vendor and the DOC, additional applications can be added via change order to the kiosk while this contract or its extensions are in effect, at the department's option.

Agreed – Keefe will comply with this requirement.

Vendor must provide any and all upgrades that become available during the term of the contract.

Agreed – Keefe will comply with this requirement.

3.2.2.1 Third Party Acquisition of Software: vendor shall notify the Department in writing if its intellectual property, business, or all of its assets are acquired by a third party.

Agreed – Keefe will comply with this requirement.

3.2.2.2 Title of Software: Vendors submitting a proposal represents and warrants that it is the sole owner of the software or, if not, the owner, has received all legally required authorizations from the owner. Vendor to provide the following documentation:

- Term of software license.

Licensed System software for Keefe's kiosk solutions includes:

- **Microsoft Win7 – embedded**
- **Microsoft Server 2008**
- **IBM DB2 ExpressC**
- **SMS-Music Manager**
- Rights to Computer Software.

Keefe writes its own software and maintains the source code as described below in 3.4 Maintenance/Service under the heading Engineering and Development Service.

3.2.2.3 Touch screen monitor shall reduce the ability to read the screen when viewed from the side to prevent others from viewing displayed information. Touch screen shall not require scrolling.

Agreed – Keefe can supply its Edge™ kiosk with privacy filter and privacy wings, if needed.

3.2.3 System Architecture

3.2.3.1 The capability for the development of future applications and implementing these applications on the proposed hardware configuration.

Keefe writes its own software and maintains the source code as described below in 3.4 Maintenance / Service under the heading Engineering and Development Service

3.2.3.2 Vendor shall ensure that the system architecture is scalable and designed to easily and inexpensively accommodate changes (future applications, etc) resulting from DOC rules and workflows.

Keefe writes its own software and maintains the source code as described below in 3.4 Maintenance / Service under the heading Engineering and Development Service

3.2.3.3 Vendor must allow for the kiosks to be data linked within an institution, and best case to be linked throughout the Department.

Agreed – the Keefe kiosk solutions are capable of IP based networking.

3.2.3.4 Provide the capability of producing reports, including but not limited to:

- Use and statistical reports by function. (i.e., Banking queries, store sales, phone time, etc; and
- Accounting reports.

Agreed – The Keefe systems are equipped with both standard and customized reports.

3.2.3.5 Provide a kiosk application that will run on a operating system designated by the DOC and is capable of being upgraded.

Agreed - Keefe's kiosk systems run on Windows and Windows embedded operating systems.

3.2.3.6 Touch screen buttons and font sizes large enough to be easily read by the majority of customers.

Agreed – Keefe's Edge™ and Secure Deposits™ kiosks are touch screen applications, and buttons and font sizes are large enough to be easily. The Secure Media™ system allows navigation at the player level.

3.2.3.7 Provide kiosk application instructions to the inmates which are clear and to the point, with no large blocks of text.

Agreed – Keefe's Edge™ kiosks provide clear and succinct instructions.

3.2.3.8 Vendor shall ensure each kiosk is maintained on the most current version of the vendor's systems of operation, with no more than two versions at any one-time across all kiosks.

Agreed - Keefe will comply with this requirement.

3.2.3.9 Kiosk Operational Statistics to include:

- At minimum, internal operational software.
- Ability to look at up-time logging data and monitor kiosks.
- Full monitoring capabilities; KVM/Power.

Agreed - Keefe's kiosks meet these minimum requirements:

- Keefe's turnkey solutions for the Secure Deposits Lobby Kiosk and the Music Manager Media Distribution Kiosk include monitoring of internal operation software, logging data, and power/uptime monitoring. Keefe supplies monitoring services for these turnkey solutions through its Technical Services and Data Center staff.
- Keefe's Edge kiosks include a replacement shell for Windows Explorer that determines hours of operation and establishes a station identification that enables restricted use by location. Active monitoring for the Edge kiosk is limited to remote desktop sharing technologies such as RDP, VNC, LogMeIn, etc.
- As Keefe writes its own application software for its kiosk solutions, additional monitoring features may be added to its kiosk solutions as negotiated through the contract resulting from this solicitation.

3.2.3.10 Data transfer in your operating system. Please include specification for eXtensible Markup Language (XML) or other standard interface options, to tie in a kiosk-based application with offender management systems.

Keefe Group Data Exchange Interfaces for KeepTrak™ ® and ACCESSCORRECTIONS®

- Keefe Group supports a variety of standardized KeepTrak™ ® and ACCESSCORRECTIONS® data exchange interfaces. These interfaces currently connect with more than 40 JMS/OMS company systems, dozens of State and county IT organization systems, and a variety of private Correctional Management systems. Although dynamic real-time interfaces are the preferred approach, Keefe Group also supports file-based batch-type interfaces when required.
- Keefe Group provides the development resources to create and support the interface code for its various KeepTrak™ ® and ACCESSCORRECTIONS® systems. Keefe Group also provides specifications to developers of partner systems for the creation and maintenance of their respective interface components in relation to Keefe Group's data exchange capabilities.
- Development costs for the KeepTrak™ ® and ACCESSCORRECTIONS® interface code created and maintained by Keefe Group software engineers are the responsibility of Keefe Group and represent no additional cost to the Agency. Because the Agency (County, Sheriff's Dept, State, Private Entity, BOP) is in the unique position of being both the customer of Keefe Group and of the partner JMS/OMS provider, the success of interface initiatives is accelerated when the Agency takes a primary role in steering the interface project.

Types of Data Exchange Interfaces Available from Keefe Group

The type of information needed for an interface will vary depending upon which functions of KeepTrak™ ® and ACCESSCORRECTIONS® the Agency plans on using.

- **KeepTrak™ ® Inmate Banking Integrations**
 - When KeepTrak™ ® Inmate Banking is used, the integration relies on read-only flows of Intake, Release, and Housing information from the OMS/JMS system to the KeepTrak™ ® Inmate Banking System. KeepTrak™ ® Inmate Banking may also be queried by the OMS/JMS for summary financial information through web-based interfaces built into the KeepTrack® Inmate Banking System.
- **KeepTrak™ ® Commissary Integrations**
 - When KeepTrak™ ® Commissary is linked to a partner inmate banking system, the integration relies on the flow of Inmate identification, funds balance, housing and privilege level information from the OMS/JMS system to the KeepTrak™ ® Commissary system. In turn the KeepTrak™ ® Commissary system forwards inmate purchase and refund transaction information to the OMS/JMS inmate banking system.
- **KeepTrak™ ® Fulfillment Center Integrations**
 - When both the inmate banking and commissary systems are provided by a partner system, the integration relies on the flow of approved item by item detailed receipt information from the partner OMS/JMS commissary system to the Keefe Group warehouse.
- **ACCESSCORRECTIONS® Deposit Services Interface**
 - When ACCESSCORRECTIONS® Deposit Services are used in conjunction with the KeepTrak™ ® Inmate Banking System the interface relies on secure IP network connections between the Agency network and Keefe Group's Centrally Managed Service Oriented Infrastructure. Keefe Group also publishes interface specifications to allow partner Inmate Banking systems to provide inmate lookup information for on-line depositors and to provide deposit posting capabilities for the partner Inmate Banking system.
- **ACCESSCORRECTIONS® Release Services Interface**
 - When ACCESSCORRECTIONS® Release Services are used in conjunction with the KeepTrak™ ® Inmate Banking System the interface relies on secure IP network connections between the Agency network and Keefe Group's Centrally Managed Service Oriented Infrastructure. Keefe Group also publishes interface specifications to allow partner Inmate Banking systems to utilize Keefe Group's Centrally Managed Service Oriented Infrastructure to provide secure timely and accurate transaction processing for inmate account settlement within a partner inmate banking system
- **KeepTrak™ ® IVR Phone Interfaces**
 - The KeepTrak™ ® IVR commissary order entry system is attachable to facility inmate phone systems. The interface relies on network connections to a facility-based or centralized phone switch. The KeepTrak™ ® IVR commissary order entry system requires the KeepTrak™ ® Commissary Module and is seamlessly interfaced with the KeepTrak™ ® Inmate Banking System. If the facility is not using the KeepTrak™ ® Inmate Banking System,

the KeepTrak™ ® IVR/Commissary solution can be interfaced with partner inmate banking systems.

- **KeepTrak™ ® DirectDebit Inmate Real-Time Phone Interface**
 - When the KeepTrak™ ® Inmate Banking System is used to charge inmate accounts for phone time as the call occurs, the interface relies on network connections to a facility-based or centralized phone switch.
- **KeepTrak™ ® DirectSales Inmate Pre-Paid Phone Interface**
 - When the KeepTrak™ ® Commissary System is used for charging inmate accounts for pre-paid phone time, the interface requires the phone vendor to connect to Keefe Group's central managed services platform to transfer pre-paid phone charges to the phone system pre-paid inmate accounts.

3.2.4 Customer Interaction Messages

Messages to be available in English and Spanish.

Agreed. As seen below, inmates have the option to choose the language displayed on the kiosk. Additional languages are currently in development.

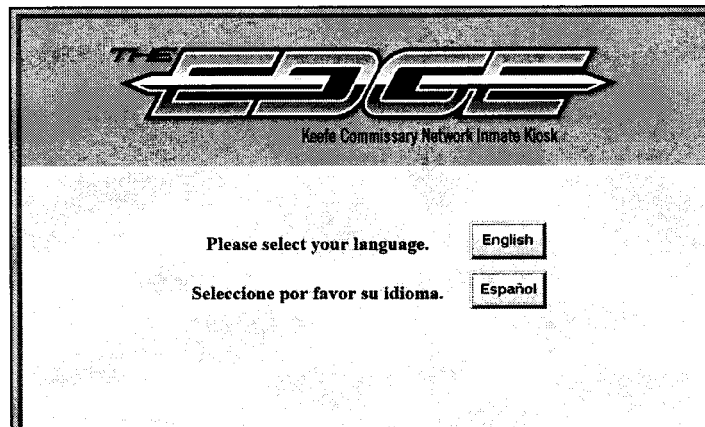

Vendors are to describe in detail the following:

3.2.4.1 Transaction processing messages;

During transaction processing, a timer is displayed.

3.2.4.2 What messages prompt the inmate during their time on the kiosk;

Each screen includes instructions to the inmate.

3.2.4.3 Error message, can the error message be customized?

Error messages are coded in sync with navigation of the Edge kiosk. Text of error messages may be modified upon request of the Participating State DOC

3.2.4.4 Does functionality include instructional prompts?

Yes.

3.2.4.5 Transaction processing messages to indicate what messages prompt the inmate during their time on the kiosk. This should include error messages.

- Can the error message be customized?

Yes.

- Does the functionality include instructional prompts?

Yes.

3.2.5 Remote Management

At minimum, remote Keyboard/Video/Mouse (KVM) reset is required.

Agreed – Keefe’s kiosks meet this minimum requirement.

3.2.5.1 Vendor to detail remote management capabilities. To include the following:

- Monitoring;
- Diagnostics;
- Error resolution;
- Software problem assistance;
- Intelligence reporting;
- Application and software updates and upgrades; and
- Rebooting and controlling the remote kiosks from a central location.

Keefe’s turnkey solutions for the Secure Deposits Lobby Kiosk and the Music Manager Media Distribution Kiosk include monitoring of internal operation software, logging data, and power/uptime monitoring. Keefe supplies monitoring services for these turnkey solutions through its Technical Services and Data Center staff.

Keefe’s Edge kiosks include a replacement shell for Windows Explorer that determines hours of operation and establishes a station identification that enables restricted use by location. Active monitoring for the Edge kiosk is limited to remote desktop sharing technologies such as RDP, VNC, LogMeIn, etc

As Keefe writes its own application software for its kiosk solutions, additional monitoring features may be added to its kiosk solutions as negotiated through the contract resulting from this solicitation

3.2.5.2 Remote management should be set through a security access designation.

Agreed – Keefe will comply with this requirement.

3.2.6 Software Provisions

3.2.6.1 Vendor shall provide any and all software upgrades that become available during the term of the contract.

Agreed – Keefe will comply with this requirement.

3.2.6.2 Third party Acquisition of Software - The vendor shall notify the department in writing if its intellectual property, business, or all of its assets are acquired by a third party.

Agreed – Keefe will comply with this requirement.

3.2.6.3 Title of Software – By submitting a proposal, the vendor represents and warrants that it is the sole owner of the software or, if not, the owner, has received all legally required authorizations from the owner.

Acknowledged and agreed.

3.2.6.4 Term of software license.

Keefe's software is offered through its turnkey services for the term of the license that engages the turnkey services.

3.2.6.5 Rights to Computer Software.

Keefe's software is offered through its turnkey services for the term of the license that engages the turnkey services.

3.2.7 Hardware Requirements

Vendor must describe the capability for the development of future applications and implementing these applications on the proposed hardware configuration.

Keefe writes its own software and maintains the source code as described below in 3.4 Maintenance / Service under the heading Engineering and Development Service.

Vendors to describe in detail the ability to provide the following:

3.2.7.1 Vendor shall provide for all electrical equipment to operate on a regular 120 volt, 60 hertz, AC power and be "UL" or equivalently listed and be certified by a Nationally Recognized Testing Laboratory to be compliant with the FCC regulations.

Supplying AC power to the Edge™ Kiosk Enclosure

Each of these power supplies plugs into a power strip supplied by Keefe Group and kept within the kiosk enclosure. To bring AC power to the enclosure, most agencies run the AC cabling in conduit either to the top or the bottom of the kiosk. Within the kiosk enclosure, Keefe Group provides a vacant wiring box for the agency to terminate the AC electrical cabling. The cabling should be terminated to a standard 110-volt AC outlet. Standard wiring specifications apply to the internally mounted AC outlet

Typical wiring instructions follow:

Strip off 1/2 inch of insulation from the end of black, white and green wires pulled out of the wall with a wire stripper. Loosen the spare (no wires attached) black and the white terminal screws on each side of the existing electrical outlet with a screwdriver. Hook the stripped end of the black wire around the gold terminal screw, and tighten the screw firmly. Hook the stripped end of the white wire around the silver terminal screw, and tighten the screw firmly. Loosen the green terminal screw, hook the bare or green wire around it, and tighten the screw firmly.

Following is a graphic of a completed AC outlet as it would be terminated within the Edge™ kiosk

Conduit and cable supplied by the Agency
Wiring Box integrated into the Edge™ Enclosure

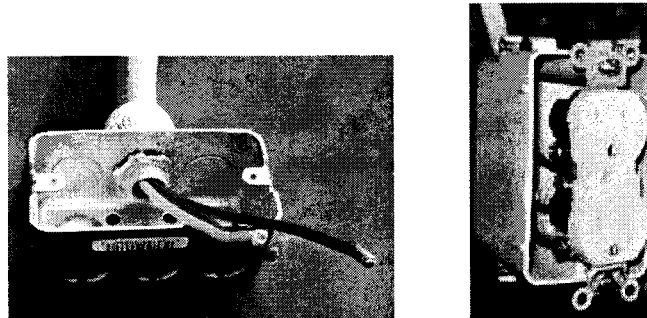

Although the termination is completely enclosed within the kiosk, some agencies also add a face-plate to cover the electrical cabling.

3.2.7.2 Monitors must be Energy Star Compliant with a minimum level of EPEAT Bronze. Monitors must be a minimum of 17" in size across the diagonal, having an associated graphics control board with video drivers. Monitor must be able to withstand operating temperatures of 110 degrees and 100% humidity.

Agreed – Keefe's kiosks comply with this requirement.

3.2.7.3 Describe alternatives for offenders with disabilities. i.e., Large print options; Text reader options for the blind; Assistive key-stroke functionality for paralyzed offenders.

The following accessibility features are included on the Edge Kiosk for inmate use

- Every image has a text equivalent
- Font sizes are not alterable by the inmate, as this navigation capability has been replaced by operating the browser in kiosk mode to provide maximum use of screen display space.
- Secure Messages are presented in text mode, document presentation such as PDF file is not enabled
- Secure Messages do not include videos

3.2.7.4 Vendor to propose solutions that would assist the visually impaired.

The following accessibility features are included on the Edge Kiosk for inmate use:

- Every image has a text equivalent
- Font sizes are not alterable by the inmate, as this navigation capability has been replaced by operating the browser in kiosk mode to provide maximum use of screen display space.
- Secure Messages are presented in text mode, document presentation such as PDF file is not enabled
- Secure Messages do not include videos

3.2.7.5 Each kiosk must have a touch screen video display monitor capable of displaying digitized photographs, graphics, and videos, etc.

Agreed – Keefe’s kiosks meet this requirement.

3.2.7.6 Touch screen monitor must be secure, safe and capable of withstanding heavy usage in a correctional environment. It must be scratch resistant. Vendor must provide any special care required to keep the screen clean, and prolong the viewing and usage life expectancy.

Agreed – Keefe’s kiosks meet this requirement

3.2.7.7 Touch screen monitor shall not be of the “overlay” or “membrane” type. If a “surface acoustic” or “capacitive” technology is not utilized, the vendor must provide an explanation of why another technology is being proposed.

Agreed – Keefe’s kiosks use **capacitive touch screen technology**.

3.2.7.8 Touch screen monitor must reduce the ability to read the screen when viewed from the side to prevent others from viewing displayed information.

Agreed – Keefe can supply its Edge™ kiosk with privacy filter and privacy wings, if needed.

3.3 SECURITY REQUIREMENTS

Vendors to describe in detail how the following security requirements will be performed:

3.3.1 System must be able to support secure wireless, if required by using facility.

3.3.2 Kiosks may or may not connect to DOC information technology infrastructure.

3.3.3 Vendor to detail plans to support their proposal both ways.

Agreed 3.3.1 - Keefe's kiosks may participate in a WiFi environment if required by using facility

Agreed 3.3.2 and 3.3.3 - Keefe's kiosks may or may not connect to DOC information technology infrastructure as required by using facility

- When connected to DOC information technology infrastructure, Keefe recommends the establishment of a VLAN environment to segregate inmate communications.
- When disconnected from the DOC information technology infrastructure, Keefe recommends VPN communications between sync points such as the Edge Web server as it might communicate with the Inmate Banking system or host facility administrative access for grievance distribution or other kiosk management capabilities.

3.3.4 Incoming e-mail is screened by the system using keyword search before download is allowed. Keyword screening would evaluate risk level of e-mail. Unacceptable or questionable (moderate to high risk) e-mail is held or staged at a central location computer for DOC approval before it is available for offender delivery or download.

- Keyword search may be edited at any time.

Agreed – Keefe's Secure Mail system complies with these requirements, and is described in detail in section 3.2.1.1.

- Offender email must be stored by vendor or transferrable to DOC storage.

Transferability to DOC storage would be subject to interface specifications to be determined.

3.3.5 Internet access/direct e-mail reply is not allowed within the Nevada Department of Corrections. Vendor to detail how this could be managed with their systems.

Agreed – please refer to response to 3.2.1.1.6 above.

3.3.6 MP3 music downloads – Player connects and accepts downloads only from the secure kiosk. No direct access to the internet within the Nevada Department of Corrections. Vendor to detail plans to support their proposal with and without direct access to the internet.

Agreed – please refer to response to 3.2.1.1.6 above.

3.3.7 Recording Video Visitations

Our video visitation system enables live and archival monitoring of visitations from any computer located in the Facility with network access (i.e., no special purpose hardware or software is required). Monitoring is performed by any user who has Monitor privileges (assigned by the Facility to any employee).

The monitoring page includes functionality that allows designated users with Monitor privileges to monitor the audio and video for each of the ongoing visitation sessions. Monitors are able to instantly terminate a session at any time by clicking a button on the page labeled “Terminate Session”.

All visitation sessions and metadata are stored for 90 days (longer if the Facility requires it) our hosting facility (or other location if required). After 90 days the videos are deleted. Our system automatically logs inmate and visitor information and associates it with the visitation. All visit metadata is stored in the database and is searchable via standard database query. Visitations can be viewed by authorized Facility personnel via the web and can be downloaded for investigation purposes and permanent storage as needed.

3.3.8 Vendor must have contractual rights to distribute digital media from major music labels or other entertainment fields to provide reasonable volume of acceptable media content.

Agreed – Keefe complies with this requirement.

3.4 MAINTENANCE/SERVICE

Keefe Group Technical Services provides four areas of services to customers on a daily basis:

1. Contact Services
2. Escalation Services
3. Data Center Services
4. Project Services.

In addition, Keefe Group develops its own software/kiosks by means of its Engineering / Development staff.

Contact Services

- The first line of contact for service requests is via phone or e-mail
 - Phone requests are routed through CISCO Call Manger on a 24 x 7 x 365 basis – phone requests are placed by dialing 800 864-5986.

- When are phone services available?
 - Business hours are defined as 8 AM – 5 PM Monday through Friday.
 - During business hours, inbound calls are answered by an administrative attendant. The administrative attendant determines whether the call is related to marketing, accounting, or technical services. If the call is technical in nature, the attendant can route the call either to the direct extension of an individual technician or to the call-queue for the first available technician.
 - Calls queued for the first available technician can travel through four staff levels, with an increasing cumulative number of extensions accessed throughout wait-time.
 - If a queued call is not answered within five minutes, the call is routed to a voice mail extension which records a message from the caller and automatically begins paging a group of six escalation phone numbers
 - Calls directed to an individual technician are subject to the current availability of that technician at the time the call is transferred.
 - Any inbound call outside of business hours can access technical support by choosing option 7 on a touch-tone phone. When option 7 is selected, the call routing routine first checks for available staffed extensions. If none are available the call is routed to a voice mail which automatically begins paging a group of six escalation extensions. On-call staff are equipped with notebook computer systems integrated with wireless internet access and VPN access to the Keefe Group Corporate Service Center.
- E-mail requests are monitored during business hours by a designated Service Center administrator.
 - The Solutions Center administrator screens e-mail either for immediate response or for escalation as a service event.
 - If escalated to a service event, the Service Center Administrator opens a CRM Case and either assigns the case to a technician or adds the case to the service ticket queue.
- Contact Services Staff are located at the Keefe Group Service Center Corporate Office in St. Louis MO Monday through Friday 6 AM – 7 PM CST
- On-Call Staff are located off premises Monday through Friday 5 PM – 8 AM, Saturday and Sunday 24 hrs per day, and Monday morning 12 AM – 8 AM.
 - On-Call staff are located at the Keefe Group Service Center Office in St. Louis MO Monday through Friday 8 AM – 5 PM
- All customer support cases are documented in Microsoft CRM. History is available to all field sales staff and regional management on a real time basis.
- Examples of first line support services
 - Resolution of communications errors
 - Analysis of hardware errors and replacement of defective hardware
 - Standard end-user training
 - Order Tracking, Order Processing, Pricing Updates

Escalation Services

- Delivery of complex helpdesk service requirements. Contact Services escalate more complex service requirements to a higher level of complexity and urgency
 - Examples of complex service requirements
 - Recovery of failed hard drive and / or data recovery
 - Re-configuration of standard software features including
 - accounting profiles
 - commissary restrictions
 - integration settings
 - communications setup
 - bank, check and cash management features
 - receipt settings
 - standard installations and upgrades.
 - Analysis and reporting of software errors
 - Specialized end-user training
 - Standard Software Upgrades

Data Center Services

- Operation and control of corporate computer systems relating to the customer
 - Hardware and software procurement and inventory
 - Customer hardware/software pre-configuration
 - Central Server Controls
 - Server Monitoring
 - Production
 - DR site
 - DR readiness
 - Data replication
 - IP address changeover
 - Telco forwarding
 - Activation Procedures
 - Customer Backup Maintenance
 - Customer backups are limited to DB2 data files
 - DB2 Backups are either
 - generated and stored at the customer site and forwarded to the Keefe Group Service Center daily through an IP connection (port 80 for http or port 443 for https)
 - The Keefe Group Data Center staff monitor forwarded backups on a weekly basis. If the forwarded backup is not current, Data Center staff open a CRM Case for follow-up by Contact Center staff to resolve the backup delay.
 - generated and stored at the customer site and not forwarded to the Keefe Group Service Center (if internet access through either port 80 or port 443 are prohibited by the customer)

- If the DB2 Backup is not forwarded to the Keefe Group Service Center, the location and timestamp of the most current backup is logged to the Keefe Group Service Center each time the customer transmits a batch of commissary orders.
 - Keefe Group Data Center staff review backup logs to determine whether backups that are not transferred to the Keefe Group Service Center are not current. If the locally stored backup is not current, Data Center staff open a CRM Case for follow-up by Contact Center staff to resolve the backup delay.

Project Services

- Planning and implementation of software, hardware and network deployments at customer sites -
 - New account – first time installation of hardware and software -
 - Project technician to receive and review approved system quote and new Keefe Group account information documents.
 - Contact account manager on any questions or inquiries regarding the account setup to ensure regional and facility expectations are met.
 - Hardware and equipment needed for the installation on site is purchased.
 - Project technician creates a Keefe Group transition document – this document may vary depending on the complexity of the new account. The document will be a working plan between Keefe and the facility. It will include some of the following topics that the project technician will gather from the key contacts at the facility:
 - Computer layout at the facility – how many computers will Keefe provide, how many computers will the jail supply that the Keefe software will be installed on
 - Jail computers – what windows operating system, size of hard drive, RAM, etc.
 - Facility network infrastructure
 - Server(s) – model, configuration details
 - Remote access – which enables Keefe Group help desk technicians assist with customer questions, inquiries, problems
 - Backup method
 - Data conversion
 - Integration details – contacts, file specifications, etc.
 - Special features / services requested – positive pay, paid check, debt write off, merge resident, Kiosks, On-line deposits, special order entry methods, prepaid sales, etc.
 - Officer roster – list of officers, officer duties, groups
 - General ledger accounts and associated GL account events
 - Number of used cash drawers
 - Facility’s current every day business flow / operations
 - Resident account events

- Recoverable charges – priority and recovery percentage
 - Order forms – commissary restrictions
 - Bank account
 - Check printing / layout
 - Software / system reports
 - Training – room / structure / end user schedule / end user manuals
- When the equipment is received in the Keefe Group office, the project technician will build and configure the hardware to meet the requests of the facility.
 - Final configuration and setup of account management, officer management, inmate banking module, commissary module, reports, etc.
 - Final configuration, setup, and testing of all integrated systems (booking, fund, sale integrations) in the Keefe Group Corp. office prior to on site implementation.
 - Prepare for on site end user training (manuals, tip sheets, user scheduling, training computers, training classroom)
 - Project technician on site visit for hardware installation, end user training, and implementation of Keefe software applications.
 - Once the on site visit has been completed, the project technician will follow up with the customer to ensure satisfaction and open items have been resolved – all detailed information is then documented in CRM.
- Current account – complex upgrade of hardware and/or software – for example, a new feature which involves changes to business processes, server and/or workstation operating system or database level, network topology, etc
 - Review of new features / equipment required for upgrade
 - Receipt of signed authorization to proceed with equipment / software changes
 - Testing of new features / hardware required for upgrade
 - Development of transition plan
 - Preparation for additional on-site training if required for the upgrade

Engineering and Development Services

- Specification and development of hardware / software solutions for correctional commissary environments. Engagement at this level requires Keefe Group corporate review / approval of customer requests sponsored by Keefe Group regional representatives on behalf of the customer.
 - Review and analysis of business requirements for new solutions and/or changes to current solutions
 - Development of design specifications for new features
 - Development of cost estimates for new features
 - Development of timelines for new features
 - Coding and Testing of new features
 - Testing and early deployment of new features
 - Maintenance for current feature set

Hardware Service Plans and Business Continuity Options
Hardware Service Agreements – repair and or replacement of defective hardware

- Hardware failures are covered under contracts with manufacturers such as Dell, Wyse, NCS, Brother, Tally Genicom, etc. These are typically 24-hour turnaround contracts for workstations, same day service for servers, and depot/warranty replacement for peripherals and kiosks. The facility may also opt to have Keefe Group provide on-site or depot service spare equipment to maximize utilization and minimize downtime in the event of hardware failure.
 - Server maintenance options are as follows:
 - Gold Dell on-site server service - would include 4-hour 24 x 7 x 365 on-site response time guaranteed by Dell Computer Corp after dispatch by Keefe Group help desk staff
 - Workstation maintenance options are as follows:
 - Standard Dell on-site workstation service - would include 8-hour 8 x 5 on-site response time guaranteed by Dell Computer Corp after dispatch by Keefe Group help desk staff
 - Depot - backup workstation service - would include the storage of a 'cold spare' workstation CPU at the Regional Distribution Center. In the event of a workstation failure at the facility, the cold spare could be installed and connected to the server database for use in a matter of hours by Keefe Group staff. At such time as the original workstation is repaired the process can be reversed at off-peak hours to re-introduce the original workstation, and return the 'cold spare' to depot status. The cost of 'depot - backup workstation service' is reflected in the cost proposal
 - Pod Kiosk maintenance options are as follows:
 - Depot – backup pod kiosk shells are stored at the regional distribution center. In the event of a kiosk failure, facility maintenance staff would be trained to remove the defective pod kiosk shell and replace it with the spare. The defective shell would be shipped to Keefe Group Technical Services to be refurbished. Once refurbished, the shell would be shipped back to the regional business center as one of the spare units.
 - Lobby Kiosk maintenance options are as follows:
 - Depot – backup lobby kiosk shells are stored at the regional business center. In the event of a lobby kiosk failure, facility maintenance staff would be trained to remove the defective pod kiosk shell and replace it with the spare. The defective shell would be shipped to Keefe Group Technical Services to be refurbished. Once refurbished, the shell would be shipped back to the regional business center as one of the spare units.
 - Monitor, modem, printer, OMR scanner maintenance options are as follows:
 - Standard peripheral replacement services - In the event of failure of one or more of these peripherals, Keefe Group will ship a replacement for next day delivery and installation by facility staff. In the event that the OMR scanner can be repaired / replaced directly by NCS and this would be a quicker

solution to return the equipment to service, Keefe Group Tech services will exercise the NCS service option.

- On-site depot peripheral replacement services - Keefe Group will store one of each of these peripherals at the regional Distribution Center. In the event of a failure of one or more of these peripherals, Keefe Group regional Distribution Center staff will replace the peripheral(s) with a spare unit, and return the failed unit to Keefe Group Headquarters Technical Services for repair or replacement by the related vendor. Keefe Group Headquarters will return a service replacement to the regional Distribution Center and have the failed unit repaired or replaced by the associated manufacturer or vendor. The cost of 'on-site depot peripheral replacement services' is reflected in the cost proposal.

Facility Preventive Maintenance Recommendations:

- Server:
 - Quarterly synchronization of RAID array and defragmentation of hard drive partitions - 6 - 8 hours per quarter
 - Quarterly update of virus software - 1 hour per quarter
 - Monthly cold boot and observance of Power On Self Test messages to insure function of RAID array, CPU and RAM - 1 hour per month
 - Bi-annual software upgrade at option of facility - 2 hours each six months
 - Daily exchange of backup tapes for nightly scheduled backup - 1/4 hour per day (no downtime required)
 - Keefe Group service technicians typically monitor and maintain the Keefe Group system that has the DB2 instance installed. Monitoring and maintenance includes daily off-site backups via secured web connection to Keefe Group's corporate data center, dial-in or VPN maintenance sessions, including database tuning, software upgrades, and assessment for hardware upgrade requirements. The client is expected to provide reasonable access to Keefe Group service tech staff on a scheduled basis to perform these maintenance functions – 1 hr per month.
- Total Annual estimated preventive maintenance downtime - 64 hours / 61,320 hours per year for one-tenth of one percent annual server preventive maintenance downtime
- Workstations:
 - Weekly cold boot and observance of Power On Self Test messages to insure function of hard drive, CPU and RAM - 1/2 hour per week
 - Bi-annual software upgrade at option of facility - 1/2 hour each six months
- Total Annual estimated preventive maintenance downtime per workstation - (64 hours of server downtime + 27 hours of workstation downtime) / 61,320 hours per year for fifteen-hundredths of one percent annual workstation preventive maintenance downtime per workstation

- OMR Scanner:
 - Weekly calibration, read head cleaning, and paper path cleaning - 1 hour per week (can be accomplished between scanning sessions when scanner is not required to be actively scanning forms)
- Total Annual estimated preventive maintenance downtime per OMR scanner - zero hours of downtime
- Miscellaneous Printers:
 - Monthly cleaning of moving parts with canned air - 1/4 hour per month per printer (can be accomplished when printer is not in use)
 - Replacement of consumables (ink cartridge, ribbon, toner) as needed - 1/4 per month per printer (can be accomplished when printer is not in use)
- Total Annual estimated preventive maintenance downtime per printer - zero hours of downtime

3.4.1 Software Modification by the vendor and Release Management.

- 3.4.1.1 Department initiated modification to the software; the vendor shall provide the following:
- Timely cost estimates; and
 - Reasonable delivery date for enhancements, as mutually agreed upon.

Agreed – Keefe will comply with this requirement.

- 3.4.1.2 The vendor will prepare software releases and stages for testing, validation and acceptance in a test environment. The Department will perform testing for authorization to proceed prior to migration to production environment.

Agreed – Keefe will comply with this requirement.

- 3.4.1.3 The vendor shall propose, provide, and describe their solution for change management. These must include at a minimum:
- Version number;
 - Description of the change;
 - How the change was initiated (i.e. user or system support);
 - Person requesting the change;
 - Person responsible for the change; and
 - Date and time of the change.

Change Management Services are provided across the various service functions described in Section 3.4 Maintenance and Service. All service and project related changes are documented in Microsoft CRM. Larger-scale projects and development projects are further documented in project management templates.

Sample Change Event Topic and Contact overview follows:

Change Management Event	Keefe Contact (TO) (primary number 800 864-5986)	Keefe Contact (CC)	Agency Contact (TO)	Agency Contact (CC)
Scheduled Outage	kcnhelpdesk@keefegroup.com mbrown@keefegroup.com	tboucher@keefegroup.com		
Unscheduled Outage	kcnhelpdesk@keefegroup.com mbrown@keefegroup.com	tboucher@keefegroup.com		
Keefe Help Desk Service Request	kcnhelpdesk@keefegroup.com	mbrown@keefegroup.com tboucher@keefegroup.com		
Escalation of Keefe Help Desk Service Request	Mbrown@keefegroup.com	tboucher@keefegroup.com jpuricelli@keefegroup.com		
Coordinated Service Request	mbrown@keefegroup.com	tboucher@keefegroup.com		
Upgrade / Implementation Project	epinkley@keefegroup.com	tboucher@keefegroup.com		

Change Management Template for Enhancements and Upgrades			
Project Milestones – TOPIC HERE	Assigned To	Date Due	Completed
Demonstrate Current Keefe Technology	Keefe	TBD	
Review Current Agency practices and procedures	Keefe	TBD	
Determine gaps between Agency practices and Keefe Group capabilities	Keefe	TBD	
Recommend best fit for practices in relation to capabilities	Keefe	TBD	
Recommend changes if needed to support Agency practices	Keefe	TBD	
Determine data migration needs if any	Keefe	TBD	
Develop data migration methods and test	Keefe	TBD	
Determine staff assignments / authorities in relation to new features	Keefe & Agency	TBD	
Develop implementation plan for changes	Keefe & Agency	TBD	
Software update if needed	Keefe & Agency	TBD	
Equipment Provisioning if needed	Keefe & Agency	TBD	
System Configuration	Keefe & Agency	TBD	
Generate documentation and store in central repository. (pc set-up and configuration/Keefe printer set-up and configuration/etc.)	Keefe	TBD	
Change-Specific Documentation Version number Description of the change How the change was initiated (i.e. user or system support) Person requesting the change Person responsible for the change Date and time of the change	Keefe	TBD	
Staff Training	Keefe & Agency	TBD	
Go Live	Keefe & Agency	TBD	

3.4.1.4 Vendor to provide maintenance and service plan to include frequency and speed of maintenance. Downtime shall not extend past a 24 hour period.

Hardware Service Plans and Business Continuity Options

Hardware Service Agreements – repair and or replacement of defective hardware

- Hardware failures are covered under contracts with manufacturers such as Dell, Wyse, NCS, Brother, Tally Genicom, etc. These are typically 24-hour turnaround contracts for workstations, same day service for servers, and depot/warranty replacement for peripherals and kiosks. The

facility may also opt to have Keefe Group provide on-site or depot service spare equipment to maximize utilization and minimize downtime in the event of hardware failure.

- Server maintenance options are as follows:
 - Gold Dell on-site server service - would include 4-hour 24 x 7 x 365 on-site response time guaranteed by Dell Computer Corp after dispatch by Keefe Group help desk staff
- Workstation maintenance options are as follows:
 - Standard Dell on-site workstation service - would include 8-hour 8 x 5 on-site response time guaranteed by Dell Computer Corp after dispatch by Keefe Group help desk staff
 - Depot - backup workstation service - would include the storage of a 'cold spare' workstation CPU at the Regional Distribution Center. In the event of a workstation failure at the facility, the cold spare could be installed and connected to the server database for use in a matter of hours by Keefe Group staff. At such time as the original workstation is repaired the process can be reversed at off-peak hours to re-introduce the original workstation, and return the 'cold spare' to depot status. The cost of 'depot - backup workstation service' is reflected in the cost proposal
- Pod Kiosk maintenance options are as follows:
 - Depot – backup pod kiosk shells are stored at the regional distribution center. In the event of a kiosk failure, facility maintenance staff would be trained to remove the defective pod kiosk shell and replace it with the spare. The defective shell would be shipped to Keefe Group Technical Services to be refurbished. Once refurbished, the shell would be shipped back to the regional business center as one of the spare units.
- Lobby Kiosk maintenance options are as follows:
 - Depot – backup lobby kiosk shells are stored at the regional business center. In the event of a lobby kiosk failure, facility maintenance staff would be trained to remove the defective pod kiosk shell and replace it with the spare. The defective shell would be shipped to Keefe Group Technical Services to be refurbished. Once refurbished, the shell would be shipped back to the regional business center as one of the spare units.
- Monitor, modem, printer, OMR scanner maintenance options are as follows:
 - Standard peripheral replacement services - In the event of failure of one or more of these peripherals, Keefe Group will ship a replacement for next day delivery and installation by facility staff. In the event that the OMR scanner can be repaired / replaced directly by NCS and this would be a quicker solution to return the equipment to service, Keefe Group Tech services will exercise the NCS service option.
 - On-site depot peripheral replacement services - Keefe Group will store one of each of these peripherals at the regional Distribution Center. In the event of a failure of one or more of these peripherals, Keefe Group regional

Distribution Center staff will replace the peripheral(s) with a spare unit, and return the failed unit to Keefe Group Headquarters Technical Services for repair or replacement by the related vendor. Keefe Group Headquarters will return a service replacement to the regional Distribution Center and have the failed unit repaired or replaced by the associated manufacturer or vendor. The cost of 'on-site depot peripheral replacement services' is reflected in the cost proposal.

Facility Preventive Maintenance Recommendations:

- Server:
 - Quarterly synchronization of RAID array and defragmentation of hard drive partitions - 6 - 8 hours per quarter
 - Quarterly update of virus software - 1 hour per quarter
 - Monthly cold boot and observance of Power On Self Test messages to insure function of RAID array, CPU and RAM - 1 hour per month
 - Bi-annual software upgrade at option of facility - 2 hours each six months
 - Daily exchange of backup tapes for nightly scheduled backup - 1/4 hour per day (no downtime required)
 - Keefe Group service technicians typically monitor and maintain the Keefe Group system that has the DB2 instance installed. Monitoring and maintenance includes daily off-site backups via secured web connection to Keefe Group's corporate data center, dial-in or VPN maintenance sessions, including database tuning, software upgrades, and assessment for hardware upgrade requirements. The client is expected to provide reasonable access to Keefe Group service tech staff on a scheduled basis to perform these maintenance functions – 1 hr per month.
- Total Annual estimated preventive maintenance downtime - 64 hours / 61,320 hours per year for one-tenth of one percent annual server preventive maintenance downtime

3.4.1.5 The successful contractor must provide support for the equipment Monday through Friday 8:00 am to 5:00 pm in participating state's time zone. Vendor must provide the toll free number for agency to call when service is needed.

Acknowledged and agreed.

3.4.1.6 Maintain levels of service and machine installation at no cost to state.

Acknowledged and agreed.

3.4.1.7 No additional installation cost for changing out machines that need repair or replacement.

Acknowledged and agreed.

3.4.1.8 The vendor will coordinate its service schedule in advance with the institution.

Acknowledged and agreed.

3.4.1.9 If ownership of equipment shall remain with the contractor, the state shall provide reasonable measures against loss by pilferage or destruction. The vendor shall be responsible for any expenses required for the repair of the equipment.

Acknowledged and agreed.

3.4.1.10 The successful vendor must provide following support services for equipment placed within state buildings, that include but are not limited to:

- Unlimited phone support;

Acknowledged and agreed within phone support protocols described in response to Section 3.4 Maintenance/Service.

- Updates and upgrades;

Acknowledged and agreed.

- Security-related updates to their proposed solution, which may be called updates, upgrades, patches, service packs, hot fixes, or workarounds.

Acknowledged and agreed.

3.5 REPORTING

3.5.1 Vendor must include in their proposal reporting capabilities for machines to be provided, to include but not limited to the following:

- Processing time per transaction;
- Number of transactions per day;
- Offender purchases;
- The number of an individual's purchases;
- Transactions rejected and rejection reason;
- The source and amount of deposits to offender accounts;
- Use and statistical reports by function. (i.e. Banking queries, store sales, phone time, etc; and
- Be able to provide custom reports as may be requested by individual participating entities. Describe in general, the level of sophistication and complexity, custom usage report data that you can provide to the participating entities. Vendors should provide a sample report with their proposal.

Agreed - Keefe will provide reports as indicated. Additionally, Keefe Group has engineered a custom interface to Seagate Crystal Reports so that technical staff can add customized reports whenever requested. These reports include but are not limited to inmate account statements, batch reports, transaction inquiries, individual inmate balance listings, housing reports, commissary order trend reports, and commissary sales roster by housing unit.

Other kiosk reports include:

- Total Sales (by dollar and by category)
 - Monthly sales by category
 - Sample invoice and sales breakdown by product class
- Commission Calculation Report
 - Sample invoice and sales breakdown by product class
- Sales detail, by inmate
 - Inmate product purchases and refunds
- Credit Reports
 - Inmate product purchases and refunds
 - Inmate receipt summary
- Inmate Sales Receipt
 - sample commissary receipts
- All reports that are available for transfer to the Inmate Banking System
 - Inmate receipt summary
 - Average Inmate Order amount
 - Commissary Restriction Report
 - More reports available by request.

Sample reports have been included in this proposal under Tab C.

3.5.2 Reporting shall be provided in the format required by MCPA/NASPO Reporting Forms (Attachment N).

The following usage reports shall be submitted for the respective quarter:

- A quarterly summary of equipment sold.
- A quarterly summary by category.

Reports are to be submitted to the lead State in the format required by MCPA (Attachment N).

Reporting Dates:

- 1st Quarter – July – September – due by November 15th
- 2nd Quarter – October – December – due by February 15th
- 3rd Quarter – January – March – due by May 15th
- 4th Quarter – April – June – due by August 15th

Agreed - Keefe will provide reports as per Attachment N.

3.6 TRAINING

Vendor to provide all training materials and user manuals.

Agreed - Keefe provides training materials and user manuals for its kiosks and kiosk services.

3.7 SYSTEM WARRANTY

Equipment must carry a minimum one (1) year warranty that it is free from defects in material and workmanship. If defects are identified, the successful vendor agrees to repair or replace defective parts promptly on a like-for-like basis without additional cost to the customer. Any and all items failing during the warranty period will be replaced promptly free of charge. Upon significant failure, the warranty period will commence again for a minimum 90 additional days. Significant failure shall be determined by the Participating State Contract Administrator.

Agreed – Keefe will guarantee the above-listed System Warranty Requirements.

3.8 DEPARTMENT OF CORRECTIONS REQUIRMENTS

3.8.1 Security

3.8.1.1 Upon approval of the contract and prior to the start of work, each of the staff assigned by the contractor and/or subcontractor to this project may be required to sign non-disclosure agreements to be determined by each participating State.

Acknowledged and agreed.

3.8.1.2 All non-disclosure agreements shall be enforced and remain in force throughout the term of the contract.

Acknowledged and agreed.

3.8.1.3 All employees of vendors entering prison grounds must adhere to NDOC Security Regulations (Attachment K).

Acknowledged and agreed.

3.8.2 Work Area/Project Preparation

Prior to commencement of work, the awarded vendor shall ensure that:

- Arrangements have been made for any disposal of waste materials per Scope of Work;
- All tools, equipment and materials are on hand; and
- Any applicable worker training has been completed and documentation is on site required.

Acknowledged and agreed.

3.8.3 Health and Safety Standards

3.8.3.1 The awarded vendor shall comply with all applicable federal, state, and local requirements for protecting the safety of the contractor's employees, building occupants, and the environment.

Acknowledged and agreed.

3.8.3.2 The awarded vendor must comply with all Federal, State and Local rules and regulations.

Acknowledged and agreed.

3.8.4 Employee Background Clearance Requirements

Upon contract award, and at least four (4) days prior to beginning work, the awarded vendor shall submit a completed Contractors Background Check Applications (Attachment M), Consent for Release of Criminal History Records form (DOC560) for each employee who will be working on this project (unless previously cleared for the Site Visit).

Note: No personnel entering the correctional facilities may be ex-felons.

Forms must be sent to:

NDOC Contracts
Attn: Martha Simas
P.O. Box 7011
Carson City, NV 89701
Phone: (775) 887-3319 / Fax: (775) 887-3343
Email: msimas@doc.nv.gov

Faxes or e-mailed forms will be accepted, but the original form must be sent by US postal mail within three (3) days or clearance may be revoked.

Acknowledged and agreed. In addition to DOC requirements, Keefe Group does its own background checks and drug testing of all employees.

3.9 OPTIONAL/OTHER SERVICES

Vendor may submit additional options. Options must be listed in detail.

Acknowledged and agreed. Keefe Group provides additional services on the next pages that may offer additional benefits to the participating states.

DEBIT CARD RELEASE PROGRAM

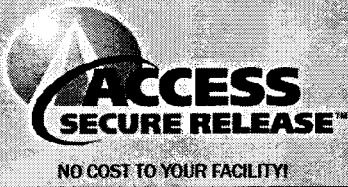

This innovative debit release card solution eliminates check fraud and cash mismanagement. When detainees are released, facilities simply load any remaining balance to a pre-paid debit card and send them on their way. The card works everywhere MasterCard is accepted.



In the last decade, correctional facilities have experienced a tremendous increase in costs associated with handling Inmate Trust Funds. In an effort to streamline and reduce costs associated with this obligation many facilities have replaced cash and checks with our debit card program. Debit cards are a cost-effective alternative to issuing traditional checks. All hardware needed to provide this service will be provided by Keefe Group at no cost.

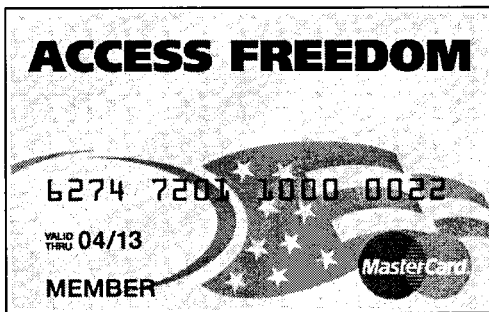

Benefits of releasing inmates with a debit card include:

- Reduces exposure to fraud and lost checks
- Easy to use
- Simplifies Bank Account Reconciliation
- Eliminates checks and cash handling

The Access Corrections debit release card is provided through our partnership with OutPaySystems. Our debit card carries the MasterCard logo and is a permanent pre-paid card upon release. This means the cardholder will immediately receive all the benefits that come with having a permanent card (Re-Load Capability, Direct Deposit from an employer, Bill Pay, etc). The card will be immediately activated at the time the funds are loaded on to the card and a PIN code will be provided to the cardholder. There are no extra steps required to activate the card. This provides the cardholder with immediate access to their funds.

Our debit card is also part of a national Credit Union Network, which means cardholders will be able to reload their card for free at any participating Credit Unions. This also means that the cardholder can get cash via an ATM without paying a surcharge fee, when using a participating Credit Union network ATM. This debit card allows inmates with or without a bank account access to their money 24 hours a day at ATM locations and Point-of-Sale locations worldwide.

By being a part of the Credit Union network, the program helps those that would otherwise not have access to a bank. Keefe Group will provide each inmate with a literacy packet that will provide with much needed information to change their banking habits and reestablish themselves on the outside.

Inmates can withdraw cash as needed from surcharge free ATM's or for free at Cash Back Point-of-Sale locations anywhere in the world. ATM's are located at convenient locations such as 7-Eleven and Greater Nevada Credit Unions which are located all across the State. For complete list of ATM locations: <http://www.co-opfs.org/public/locators/atmlocator/>.

The facility can load the card with as little as \$0.01 or as much as \$9,700.00. There is also no fee to load the card. All funds are on deposit at an FDIC insured bank. Every inmate qualifies for this program and can be issued a debit card regardless of immigration status.

Work Release

Keefe Group’s debit card program can also be used for Work Release inmates. This provides a convenient and more secure method for providing inmates their weekly allowance. The debit card has many security controls and features that would be beneficial for the work release population:

- * Restrict card usage by zip code, SIC codes, dollar amounts
- * Ability to monitor transactions by merchant location and time of transaction
- * Ability to adjust the amount of funds available for use on the card
- * Monitor Balance
- * Limit the time of day a card can be used
- * Facility can have the inmates monies direct deposited into this account or you can load the inmate’s account from the Trust Account.

NO Cost to facility	YES
Eliminate Checks/Cash	YES
Reduces Lost Checks/Fraud	YES
Simplifies Bank Account Reconciliation	YES
Real Time Transactions	YES
Robust API for system to system integration	YES
NO Load Fee	YES
MasterCard Logo Pre-Paid Debit Card	YES
Is the card assigned to the cardholder?	YES
Can the card be replaced if lost or stolen?	YES
Minimum amount that can be loaded?	\$0.01
Maximum amount that can be loaded?	\$9,700.00
Can a card be issued if the inmate does not have a Social Security #?	YES

NO Load Fee	YES
Immediate Funds Availability	YES
Weekly User Maintenance Fee ** First weekly service fee is charged 36 hours after release	\$1.50
Card issued is a Reloadable Pre-Paid Debit Card	Yes -FREE
Ability to withdraw money from the card without incurring fees by going to a grocery store within 36 hours, buying an item and getting balance via card cash back	YES
Permanent Card upon Issuance	YES
Security of PIN Protected Card	YES
MasterCard Logo Pre-Paid Debit Card	YES
POS and Pin based transactions	Both - FREE
Payroll Card - Direct Deposit Capability	YES - FREE
How many times can the card be reloaded?	Unlimited
Where can the card be reloaded?	Credit Unions, other retail locations
Is there an option to load for free?	YES, Credit Unions,
No ATM Surcharge fees at Credit Unions	YES
Bill Pay Online?	YES
Is the card assigned to the cardholder?	YES
Can the card be replaced if lost or stolen?	YES
Does the card allow for cash back at POS terminals for FREE	YES
Are the cards accepted World Wide?	YES
Is there an option to change the PIN number, for FREE?	YES
What does a customer service call cost the cardholder?	FREE
Account transaction history on line / by IVR ?	YES
Access to a membership Bank relationship? Credit Union.	YES -FREE

Data Required to Issue Card

The only information required to load/activate a debit card is the first/last name and the Date of Birth of the inmate. The activation can also set it up so that the Inmate ID number will also have to be provided for further assurance of identity. We can provide an API to the facility that will allow the data to be up loaded into our system without any manual keying of information/data. Once our system validates the cardholder profile the funds are transferred from the trust account onto the cardholder's account. This system will remove any human involvement thus reducing mistakes and fraud. If a card was accidentally loaded the funds can be reversed and removed from the card, thus allowing for the corrections of any mistakes.

Requirements to Activate Card

The debit card is activated upon the loading of the card. No further action would be required.

Security Controls

For added security we offer a PIN Debit card that requires a PIN number to be entered to process the transaction. The debit card will have world wide acceptance at all PIN Debit Terminals and ATMs. The benefit is that no one else would be able to use the card unless the cardholder provided that security PIN number.

In the event that a cardholder loses their card, they will notify us and we will freeze the account and reissue a card. We provide online access to account balance and transactional history as well as the ability to change PIN numbers for additional fees. Each debit card also carries the MasterCard logo.

Reloading Capabilities

We will also provide the cardholder the ability to reload their cards at no cost thru participating Credit Unions.

Inmate Release Card Program Benefits

- ❖ Our program provides the most cost effective program for your facility and the inmates.
- ❖ All POS are free and the inmate can request cash back.
- ❖ Almost all taxis accept debit cards and all grocery and convenience stores accept debit cards.
- ❖ With a check the inmate has to go to the bank or check cashing store to get it cashed. With the debit card the inmate will have instant access to their funds.

PAROLE & PROBATION PAYMENTS

Should the participating state desire, Keefe Group can accept payment for parole and probation fees through our lobby kiosks, and via the web and phone.

KEEPTRAK SOFTWARE

Keefe Group's software system, **KeepTrak**, enables your facility to set up accounts, journals and reports that are custom made to fit your needs.



True Windows® software

So easy to use! Whether you are managing inmate orders or medical bills, **KeepTrak** provides you with the software and technical support you need to manage your inmate welfare account.

As your partner, we make it our mission to understand the needs of your facility and provide you with the easy-to-use solutions you desire. We have a full-time software development team, completely dedicated to product advancement.

In addition to the tools we provide, your data may be accessed at your discretion by popular PC products such as Microsoft Access®, Paradox®, FoxPro® and other ODBC compliant products.



An **Inmate Accounting** module offering convenient and flexible booking and releasing inmates, modifying inmate information, processing financial transactions, and viewing all resident transactions

A **Bank Reconciliation** module that matches bank transactions to banking statement totals, allows users to enter bank statement data, clears and voids transactions, and prints reconciliation reports

A **Visual General Ledger** that is both a journal and a report generator, allowing users to set up a chart of accounts, create transactions, and utilize a full range of content sensitive reports, such as trial balance and transaction history.

K Keefe Commissary Network

File Session Control Current Drawer Transaction Configure Mode Help

JONES

Inmate Accounts **JONES, JANE** Encumbered: \$0.00
 Recoverable: \$0.00
 Held: \$0.00

Jail ID# 47987 DOB: 02/14/1970
 Block: POD Tier: Cell: A
 Avail/Rsvd: \$35.00 / \$0.00
 Status: Active

Clear Print Make Entry

Drawer Transactions | Batch Transactions | Resident Transactions |

Transaction Type Purpose / Reason Receipt Amount

<VISIT DEPOSIT> 0.00

Date	Transaction	Description	Amount	Balance	Due	Held	Reference
12/10/2007	<MEDICAL >	Payment for MEDICAL on 2007-03-30...	-10.00	35.00	0.00	0.00	
12/10/2007	MONEY ORDER	TEST	45.00	45.00	10.00	0.00	
03/30/2007	CASH DEPOSIT	INITIAL DEPOSIT - REINSTATE	0.00	0.00	10.00	0.00	
03/30/2007	MEDICAL	3-25-07	10.00	0.00	10.00	0.00	
03/29/2007	WCHECK	RELEASE OR CLOSEOUT TRANSA...	-5.71	0.00	0.00	0.00	
03/26/2007	<MEDICAL >	Payment for MEDICAL on 2005-04-14...	-2.00	5.71	0.00	0.00	
03/26/2007	<MEDICAL >	Payment for MEDICAL on 2005-04-11...	-6.00	7.71	2.00	0.00	
03/26/2007	<MEDICAL >	Payment for MEDICAL on 2005-04-05...	-6.00	13.71	8.00	0.00	
03/26/2007	<MEDICAL >	Payment for MEDICAL on 2005-04-04...	-6.00	19.71	14.00	0.00	
03/26/2007	<MEDICAL >	Payment for MEDICAL on 2005-04-01...	-5.19	25.71	20.00	0.00	
03/26/2007	CASH DEPOSIT	INTAKE	30.90	30.90	25.19	0.00	
04/14/2005	MEDICAL	4/6/05	2.00	0.00	25.19	0.00	
04/11/2005	MEDICAL	4/7/05	6.00	0.00	23.19	0.00	
04/05/2005	MEDICAL	4/3/05	6.00	0.00	17.19	0.00	
04/04/2005	MEDICAL	3/31/05	6.00	0.00	11.19	0.00	
04/01/2005	<MEDICAL >	3/23/05	-0.81	0.00	5.19	0.00	
04/01/2005	MEDICAL	3/23/05	6.00	0.81	6.00	0.00	
03/28/2005	EPR	OID:100004890-ComisatyPurch-Reg	-4.36	0.81	0.00	0.00	
03/28/2005	CASH DEPOSIT	INTAKE	5.00	5.17	0.00	0.00	
01/04/2005	BALFWRD	BALANCE FORWARD	0.17	0.17	0.00	0.00	

Ready SERVER (001)



A **Commissary** module that allows users to add Keefe Group and On-site items, create, modify, and add items, create and modify spending groups, and scan or hand key inmate orders. Manage your commissary with the ease you desire. This commissary modules gives you the flexibility to restrict commissary goods as needed.

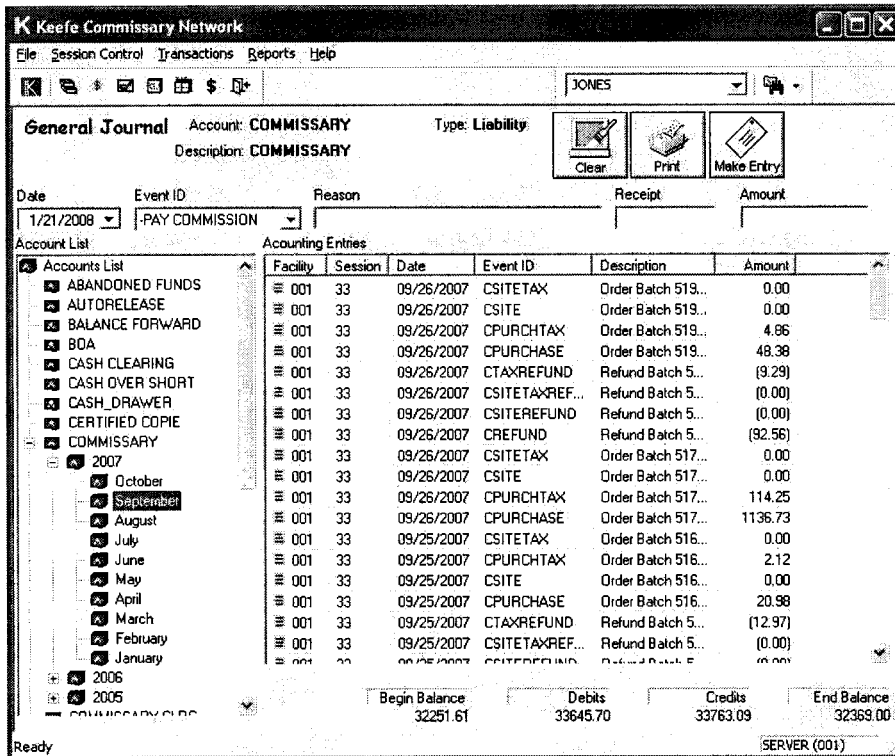

KeepTrak™ Inventory Capabilities

The KeepTrak™ Inventory software functionality includes

- Vendor setup and profile
- Warehouse setup and profile
- Item maintenance classification and pricing
- Purchase order management and rules based purchase recommendations
- Count sheet for physical inventory and inventory adjustments
- Cost of Goods Sold and On-Hand reporting and audit trail.
- The inventory system is integrated in real time with the KeepTrak™ Fulfillment Center System and the KeepTrak™ Commissary point of sale mode

Understanding the Warehouse System

KeepTrak's Warehouse feature is an inventory management system.

- ❑ **The KeepTrak system automatically tracks inventory. When products are needed, users at warehouses create purchase order requests.**
- ❑ **Users then electronically transmit the PO requests to a Distribution Center.**
- ❑ **Products are pulled from the shelves at the Distribution Center and shipped to the warehouse.**
- ❑ **Warehouses then ship the products to the appropriate store.**

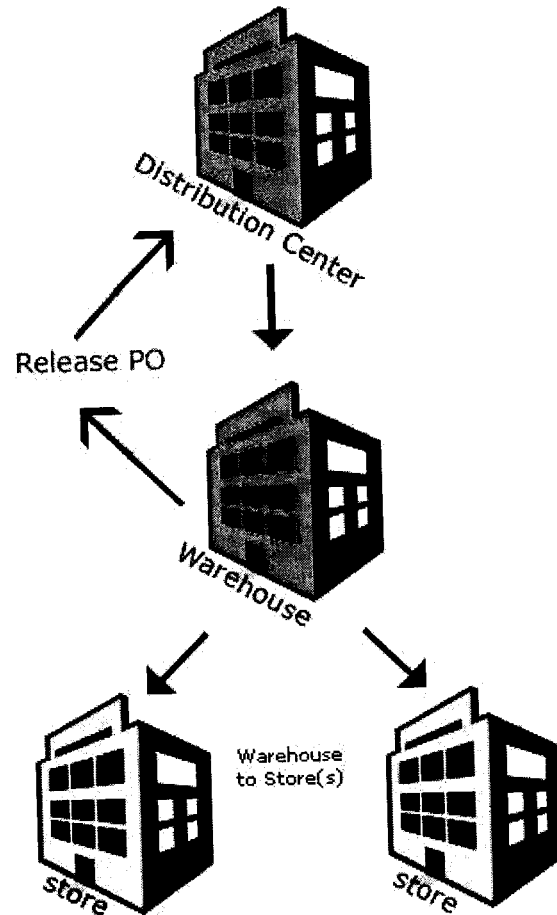

Warehouse Software Main Features and Functions

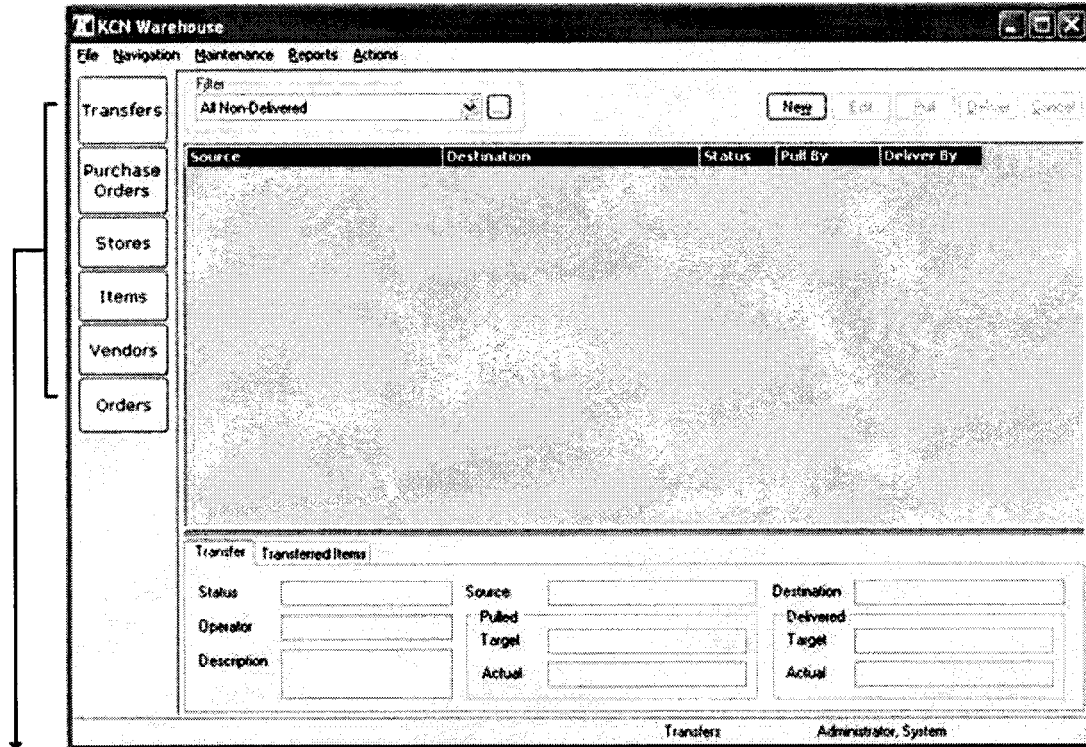

Transfers

The transfer option allows users to move stock from one location to another.

Purchase Orders

The Purchase Orders option allows users to create purchase orders by adding items.

Stores

The Warehouse Stores feature allows users to set up safety levels, enter product types, and view incoming transfers.

Items

The Warehouse Items option provides a view of all items and allows users to manually add items to the software system.

Vendors

The Warehouse Vendors option allows users to view all vendors, set up a vendor profile and associate products with vendors.

Orders

The Warehouse Orders option allows users to produce refunds.

CELL PHONE DETECTION

The problems caused by contraband cell phones in prisons and jails throughout the United States have exploded in recent years. Riots have been coordinated, assassinations ordered and gang activity organized by more and more inmates using illegal cell phones.

Keefe Group has recently combined its software development efforts with its partner CellAntenna. CellAntenna is an industry leader focused and dedicated to developing affordable and effective solutions for detecting and managing the use of contraband and unauthorized cellular phones.

Should the state be interested, Keefe will gladly discuss the details of this service.

3.10 DOCUMENTATION

3.10.1 Detailed technical system documentation and system design specifications, descriptions of all proposed kiosk hardware and software, operating instructions, footprints, power and environmental requirements, model numbers, makes, serial numbers, electrical and grounding requirements, temperature and humidity ranges, software components and features, etc.

Agreed – please see response to section 3.1 Kiosks.

3.10.2 As applicable, prior to production implementation, the successful vendor shall provide to the DOC detailed technical system documentation, detailed system design specifications, descriptions of all proposed kiosk hardware and software, operating instructions, footprints, power and environmental requirements, model numbers, makes, serial numbers, electrical and grounding requirements, temperature and humidity ranges, software components and features, etc.

Acknowledged and agreed.

4. PROJECT TERMS AND CONDITIONS

4.1 Contractual Special Terms and Conditions

4.1.1 Participating Addendum – Individual Participating States may, through a Participating Addendum, limit:

4.1.1.1 The awardees;

4.1.1.2 Available financial vehicles;

4.1.1.3 Equipment Groupings, segments, models, standardized configurations, available accessories, available software;

4.1.1.4 Exclusion of geographical areas;

4.1.1.5 As well as additional items as deemed necessary by the Participating State.

4.1.1.6 States may also, through the Participating Addendum, expand or restrict these options for Participating Political Subdivisions.

5 COMPANY BACKGROUND AND REFERENCES

5.1 PRIMARY VENDOR INFORMATION

Vendors must provide a company profile. Information provided shall include:

5.1.1 Company ownership (sole proprietor, partnership, etc).

5.1.1.1 Incorporated companies must identify the state in which the company is incorporated and the date of incorporation. **Please be advised**, pursuant to NRS §80.010, incorporated companies must register with the State of Nevada, Secretary of State's Office as a foreign corporation before a contract can be executed between the State of Nevada and the awarded vendor, unless specifically exempted by NRS §80.015.

State in which company is incorporated: State of Delaware

Date of incorporation: 1974

5.1.1.2 The selected vendor, prior to doing business in the State of Nevada, must be appropriately licensed by the Office of the Secretary of State pursuant to NRS §76. Information regarding the Nevada Business License can be located at <http://sos.state.nv.us>. Vendor's must provide the following:

We have procured and will continue to procure any/all licenses and permits required to continue doing business as required by this contract. Copies of our business license and Certificate of Existence with Status in Good Standing have been included in the "State Documents" tab (Tab B) of this proposal. Keefe has been providing the State and NDOC with products for inmate stores for over fifteen years. Our successful package program has been in place with the State of Nevada for ten years.

- Nevada Business License Number

NV19991067432

- Legal Entity Name

Keefe Commissary Network, L.L.C.

- Is "Legal Entity Name" the same name as vendor is doing business as? Yes No
If "No," provide explanation.

The Keefe Group is comprised of Keefe Supply Company, Access Catalog Company L.L.C. and Keefe Commissary Network L.L.C.

5.1.2 Disclosure of any alleged significant prior or ongoing contract failures, contract breaches, any civil or criminal litigation or investigation pending which involves

the vendor or in which the vendor has been judged guilty or liable with the State of Nevada.

There are no prior or ongoing contract failures, contract breaches, or any civil or criminal litigation or investigation pending which involves Keefe Group or in which Keefe Group has been judged guilty or liable with the State of Nevada.

5.1.3 Location(s) of the company offices and location of the office that will provide the services described in this RFP.

As members of the community, we recognize the importance of keeping and creating employment opportunities in the state. Keefe is a resident of the State of Nevada and currently employs 95 staff at our 110,000 square foot distribution center in Reno.

We are also a resident of the states of Arizona, Ohio and Virginia.

Keefe Group has several additional West Coast distribution center locations. We operate five warehouses on the West Coast, should a back-up be required for some unforeseen reason. **Our local management and warehouse, technical resources, superior inventory levels to limit shortages, and product selection making Keefe Group the preferred provider of commissary services on the West Coast.**

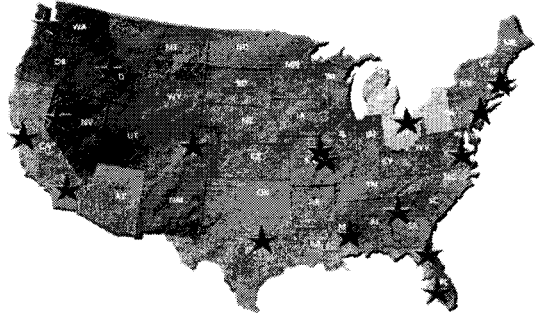

Locations of the offices that will provide the services described in this RFP:

For the Nevada portion of this RFP the below locations will provide services. One or more of our locations will provide services to other participating states depending on their location.

Keefe Group
55 Vista Blvd
Sparks, NV 89434

Keefe Group
13369 Valley Blvd.
Fontana, CA 92335

Nationally, Keefe Group currently operates 16 distribution centers totaling over 1,400,000 square feet, shipping over 22 million pounds of inventory per month, and carrying over \$68 million in inventory daily.

5.1.4 Number of employees both locally and nationally.

Keefe Group has 459 employees in the Western Region and 2,110 employees nationally.

- In Nevada, we have 30 employees on-site at DOC facilities and 95 employees at our 100,000 square foot Sparks, NV warehouse.
- In Arizona, we have an office in Phoenix and 94 employees on-site at DOC facilities.
- In Virginia, we have 95 employees on-site at DOC facilities and 25 employees at our 15,500 square foot Chesapeake warehouse.
- In Ohio, we have 60 employees at our 100,000 square foot warehouse.

5.1.5 Location(s) from which employees will be assigned.

Keefe Group
55 Vista Blvd
Sparks, NV 89434

Keefe Group
13369 Valley Blvd.
Fontana, CA 92335

5.1.6 Name, address and telephone number of the vendor's point of contact for a contract resulting from this RFP.

Jim Perry
(800) 411-0454
13369 Valley Blvd.
Fontana, CA 92335
jperry@keefegroup.com

Jim Perry, Western Region Vice President

Jim Perry, Western Region Vice President, has been with Keefe Group since 1999. Jim joined Keefe Group upon graduating from college. Jim started as an Account Manager in St. Louis and moved to California in 2004. He was promoted to Regional Sales Manager and Regional Vice President for one of Keefe Group's companies, Access Securepak. Jim was instrumental in launching and expanding Access Securepak. In 2008 he was promoted to oversee Keefe Group's Western Region business. In 2010 was promoted to Western Region Vice President overseeing Western Region sales in a nine state area of the Western United States. He is based in Fontana, CA. He holds a Bachelor's Degree from Washington University in St. Louis, Missouri. Jim is in Fontana, CA and may be reached at (800) 411-0454.

Dennis Dempsey, Regional Vice President

As Regional Vice President, Dennis oversees bulk sales in the Western Region. He is also responsible for the states of Oregon, Washington and Alaska and is in charge of managing our 110,000 sq. ft. Reno NV warehouse. After graduating from C.S.U. Sacramento, Dennis started his career with Enterprise Rent-A-Car in February 1989 and worked for 15 years eventually becoming an Area Manager overseeing 50

employees. He moved to the Keefe Group in April 2003 as an Account Manager and was promoted to Regional Sales Manager for our Reno operations in January 2006. In 2008 Dennis was promoted to Regional Vice President. **Dennis is based locally in Reno, NV and can be reached at (800) 890-5206.**

Angelo Leber, Account Manager

Angelo began his career with Keefe Group in 2007. Angelo is responsible for the states of Nevada and Arizona and will be your primary contact. Angelo majored in Business Management at San Jose State University where he was part of the Varsity baseball team for 2 seasons before he signed a professional contract. His correctional commissary experiences include: operations, security, technology options, delivery, and menu preparation. **Angelo is based locally in Reno, NV and can be reached at (800) 890-5206.**

5.1.7 Company background/history and why vendor is qualified to provide the services described in this RFP.

Keefe Group Company History and Background:

In 1975, Keefe Supply Company entered the correctional market by supplying single serve coffee packets to a Florida prison. Soon to follow, Keefe pioneered the packaging evolution of products sold through correctional commissaries all over the country. The first of many successes, Keefe began packaging instant coffee and Tang in sealed paper pouches, eliminating the presence and hassles associated with glass jars.

Since then, Keefe has served the correctional market exclusively and has been the industry leader and nation's largest provider in commissary products and services. Keefe offers the finest quality of products, uniquely packaged for consumption by offenders, and unrivalled for depth, variety and innovation.



Keefe Commissary Network provides automated commissary service to county, city and state correctional facilities nationwide. Since its inception in 1993, KCN has developed cutting edge software that's easy to use and helps customers efficiently and effectively manage their commissary operations.

KCN has become the leading and largest commissary management provider in the nation. Whether your facility houses 50 offenders or 90,000, Keefe Group gives you the flexibility and convenience you need to manage your commissary.



As we head into the future, we will continue to find ways to improve our service and products. No matter what issues you face, we will continue to listen. During the past 36 years, the industry has taken us in new directions, and we look forward to working together to address the exciting challenges that lie ahead. The Centric Group Limited Liability Company (L.L.C.), formerly known as the Enterprise Capital Group, was established in 1974 to diversify the financial interests of the Jack C. Taylor family, owners of Enterprise Rent-A-Car. Centric Group L.L.C. was formed in July, 1999 when the Enterprise Capital Group was spun out

from Enterprise Rent-A-Car. The Centric Group is the managing parent company of four (4) principal businesses: the Keefe Group, Boone Valley Golf Club, Inc., Courtesy Products/Packaging and TRG Group. Combined, the Centric Group achieved sales of over \$724 million in 2010, with 2,427 employees. The Keefe Group, comprised of Keefe Supply Company, Access Catalog Company L.L.C. and Keefe Commissary Network L.L.C., is the major contributor to Centric Group's revenues with staffing of 2,110 employees nationwide and 2010 sales of \$626 million.

In its 36 year history, Keefe has become the leading manufacturer and distributor to the correctional market, serving 1,987 institutions nationwide. Responsive customer service, high quality products, and value have been the key reasons why customers value our offerings above those of our competitors.

- During its history, Keefe Group has grown more rapidly than the market itself, increasing its market share by offering superior technology, services and product value.
- Keefe Group services more inmates than all its competitors combined including: Mid-States, Union/Food Express, Jenny, Swanson, ARAMARK, and Canteen, etc.
- Our Edge pod kiosk is the leading self service inmate ordering system in the country. We have 850 housing kiosks deployed in over 100 facilities nationwide.
- Keefe is the only commissary company to design, assemble and support our own kiosks and write, support and maintain our own inmate banking, inventory and commissary software.
- Our MP3 program runs on our own network and is the only proven correctional MP3 program currently operating in 8 state-wide DOC's with two additional awards currently launching. In addition, several other facilities, including BOP and ICE facilities, take advantage of our unique program which has delivered more than 2 million songs successfully to thousands of inmates.
- Keefe Group's Secure Mail program is proven and is currently deployed at the Mississippi DOC – 16,000 inmates, Arkansas DOC – 13,000 inmates, Idaho DOC – 4,000 inmates and has a pilot running at the Massachusetts DOC. An additional program launch is scheduled at the New Hampshire DOC – 2,400 inmates

The graphic below illustrates the current commissary market with Keefe Group's growth relative to other providers.

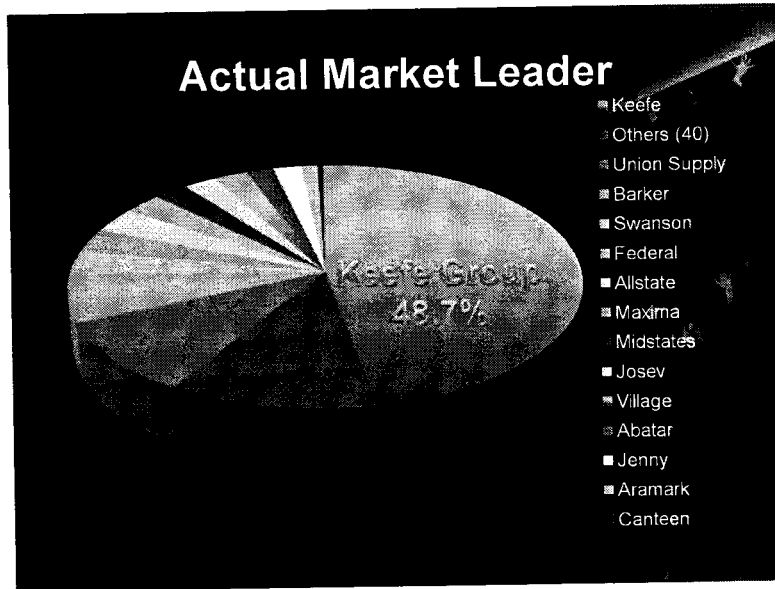

5.1.8 Length of time vendor has been providing services described in this RFP to the **public and/or private sector**. Please provide a brief description.

In its 36 year history, Keefe has become the leading manufacturer and distributor to the correctional market, serving 1,987 institutions nationwide. Responsive customer service, high quality products, technology, innovation and value have been the key reasons why customers value our offerings above those of our competitors.

5.1.9 Has the vendor ever been engaged under contract by any State of Nevada agency?
 Yes No If "Yes," specify when, for what duties, and for which agency.

In addition to being the Department's current commissary vendor, we have a strong partnership that spans the last 15 years. Additionally, we provided the state with our year round family package program. Keefe Group values our partnership with the state and will continue to not just meet, but exceed the department's expectations.

5.1.10 Is the vendor or any of the vendor's employees employed by the State of Nevada, any of its political subdivisions or by any other government?
 Yes No If "Yes," is that employee planning to render services while on annual leave, compensatory time, sick leave, or on his own time?

For the state of Nevada's package program, Keefe Group utilizes 30 DOC employees to hand out packages. This work is done on the employees' own time.

5.1.11 Resumes for key staff to be responsible for performance of any contract resulting from this RFP.

Formal resumes for the following management staff have been provided on the next pages.

Jim Perry, Western Region Vice President

Jim Perry, Western Region Vice President, has been with Keefe Group since 1999. Jim joined Keefe Group upon graduating from college. Jim started as an Account Manager in St. Louis and moved to California in 2004. He was promoted to Regional Sales Manager and Regional Vice President for one of Keefe Group's companies, Access Securepak. Jim was instrumental in launching and expanding Access Securepak. In 2008 he was promoted to oversee Keefe Group's Western Region business. In 2010 was promoted to Western Region Vice President overseeing Western Region sales in a nine state area of the Western United States. He is based in Fontana, CA. He holds a Bachelor's Degree from Washington University in St. Louis, Missouri. Jim is in Fontana, CA and may be reached at (800) 411-0454.

Dennis Dempsey, Regional Vice President

As Regional Vice President, Dennis oversees bulk sales in the Western Region. He is also responsible for the states of Oregon, Washington and Alaska and is in charge of managing our 110,000 sq. ft. Reno NV warehouse. After graduating from C.S.U. Sacramento, Dennis started his career with Enterprise Rent-A-Car in February 1989 and worked for 15 years eventually becoming an Area Manager overseeing 50 employees. He moved to the Keefe Group in April 2003 as an Account Manager and was promoted to Regional Sales Manager for our Reno operations in January 2006. In 2008 Dennis was promoted to Regional Vice President. **Dennis is based locally in Reno, NV and can be reached at (800) 890-5206.**

Angelo Leber, Account Manager

Angelo began his career with Keefe Group in 2007. Angelo is responsible for the states of Nevada and Arizona and will be your primary contact. Angelo majored in Business Management at San Jose State University where he was part of the Varsity baseball team for 2 seasons before he signed a professional contract. His correctional commissary experiences include: operations, security, technology options, delivery, and menu preparation. **Angelo is based locally in Reno, NV and can be reached at (800) 890-5206.**

Robert Marino, Keefe Group Western Region, Account Manager (Local/Regional Technical Specialist)

Robert Marino has been with Keefe Group since July 2006. He manages technical issues, installs hardware and has trained numerous customers on how to use our Keefe Group software. Robert earned his Masters in Business Administration from California State University in 2003, concentrating on Information Management. **Having a local technical specialist available for immediate support is yet another reason Keefe Group is superior to other vendors.** As a Laboratory Trainer and as a Helpdesk Manager, Robert gained a variety of practical experience serving the CSU Data Center. **Robert Marino was the lead technician for the install of sixty inmate ordering kiosks at Los Angeles County.** Robert Marino may be reached at (800) 411-0454.

Kris Dick, Regional Operations Manager

Kris Dick joined the Keefe/Keefe Group team in August 2004. Kris came to Keefe Group with six years of warehouse management experience from the military. Kris's local warehouse duties

include overseeing all receiving and shipping operations in Fontana, all Keefe Group order fulfillment, monitoring truck lines, inventory levels, employee training and support. He has been called upon on numerous occasions throughout our region for various duties such as training other regional managers, implementing new delivery schedules and operational planning, supply line logistics, and a host of other responsibilities. Kris currently serves as Operational Manager for such large accounts as **Los Angeles County, Kern County, Riverside County and Santa Barbara County among others.**

Keefe Customer Service Department

For more than 35 years, the Keefe Customer Service team has upheld a mission to be accountable for the ultimate satisfaction of our customer. Our current Customer Service family features more than 150 combined years of experience, with many of our representatives servicing the same accounts for over a decade. These combined years of experience reflect the pride that our team takes in providing you with superior service. We understand that the cornerstone of a lasting partnership is exceptional service, so we always make it our top priority.

Jim Perry, Keefe Group Regional Vice President

**13369 Valley Blvd.
Fontana, CA 92335
(800) 411-0454
jperry@keefegroup.com**

**May 2009 to present
Regional Vice President
Keefe Group
Fontana, CA**

Responsible for Keefe Commissary Network accounts in a seven state area of the Western United States with sales totaling over 55 million. Significant involvement in Keefe's privatized commissary services provided to the State of Arizona (35,000 inmates).

**August 2006 – May 2009, Regional Vice President
Keefe Group
Fontana, CA**

Responsible for Access Securepak accounts in a seven state area of the Western United States with sales totaling over 30 million. Jim was Instrumental in the creation and expansion of Keefe Group's Access Securepak and Direct Inmate programs including programs in the States of California, Nevada, Tennessee and Wisconsin.

**April 2004- August 2006, Regional Sales Manager Access Securepak
Keefe Group
Fontana, CA**

**January 1999-April 2004, Account Manager
Access Catalog Company
St. Louis, MO**

EDUCATION

Washington University, 1998
Bachelor of Arts

Dennis Dempsey, Regional Vice President

55 Vista Blvd #101
Sparks, NV 89434
800 890 5206 Office
775 250 2288 Cell
ddempsey@keefegroup.com

04/03 – Present
Regional Vice President
Keefe Group,
Reno, NV

As Regional Vice President of our Reno Distribution Center, Dennis is responsible for all aspects of the operation including Sales, Production, and Customer Service. He is also responsible for the States of Washington, Oregon and Alaska as the Account Manager. He oversees our operation in Kent, WA and the 10,000 jail inmates they service.

02/89 – 04/03

Enterprise Rent A Car
Area/District Manager
San Jose, CA

As an Area Manger for Enterprise (Keefe's Parent Company), Dennis was responsible for over 50 employees and 7 rental branch locations. His primary focus was increasing sales and customer satisfaction by hiring, mentoring and directing his employees to reach their Branch and Personal goals. He was also involved with Fleet Planning and ongoing cost controls.

Dennis has over 22 years of experience with our company in mostly management and leadership roles.

Education

C.S.U. Sacramento (1988)
BS-Finance

Angelo Leber Account Manager

55 Vista Blvd #101
Sparks, NV 89434
800 890 5206 Office
314 560 7980 Cell
aleber@keefegroup.com

11/07 – Present
Account Manager
Keefe Group, Keefe Group, Access Corrections
Reno, NV

As an account manager with Keefe Group, Angelo is responsible for all aspects of customer satisfaction, new products/services and support for customers in Arizona, California and Utah which include the Utah DOC and AZ DOC. In addition, to working with several Federal Correctional Facilities in AZ and CA, he works closely with several county jails ranging from 60 beds to over 2000. Some of the jails of note include: Pima County Jail (2000), Salt Lake County Jail (2200) and some surrounding jails like Coconino (475), Navajo (600).

3/05 – 10/07

Image Microsystems
Sales Manager / Business Development
Austin, TX

As the Sales Manger, Angelo was responsible for creating and growing the eCommerce division of the company. This division included: notebooks, PCs, related parts and warranty repair for iPods and notebooks at Best Buy. Along with managing 4 employees and running the sales division, he ran the eWaste recycling efforts and all aspects of project management for each recycling job. Customer Service, quality and partner growth were important aspects of his position at Image Microsystems.

Education

San Jose State University
De Anza Jr. College
Archbishop Mitty High School

Robert Marino, Keefe Group Regional Technical Specialist

13369 Valley Blvd.
Fontana, CA 92335
(800) 411-0454
rmarino@keefegroup.com

July 2006 – present
Keefe Group
Regional Technical Specialist

- Manage a staff of 17 consisting of help desk analysts, sales personnel and administrative staff in supporting 300 employees across 7 states.
- Assess and troubleshoot client IT problems; Address issues either remotely or travel onsite to resolve.
- New client account installation (servers, LAN, end user, training); Performed over 30 client installations and start-ups.
- Manage and develop methods to increase new client base and increase client efficiencies and satisfaction.
- Develop resources and staff.

May 2001 to February 2004
California State University, San Bernardino, CA
Computer Technician

March 1998 to August 2000
Crown Packaging International, Chicago, IL
Account Manager

Awards/Certificates of Achievement

- Designed, implemented, and launched technology projects for Los Angeles, San Diego, Riverside, Kern, Washoe, Clark, Spokane, and Yuma Counties.
- Awarded Los Angeles County “Quality and Productivity” Award for Kiosk project – 03/10.

Technical Expertise

- **Systems:** Windows (95, 98, 2000, XP, Vista, Server, CE) Linux, Redhat, Novell
- **Hardware:** Kiosks, Servers, Laptops, Towers, Routers, Switches, Hubs
- **Software:** Microsoft Office, Microsoft CRM, Adobe Photoshop, ALICE
- **Networking:** LANS, WANS, Wi-Fi, Fiber Optics, T1, TCP/IP, FTP

Education

- **MBA/Information Management**, California State University, San Bernardino (2001-2003)
(Journalist and Photographer – Coyote Chronicle, Talk Show Host – Coyote Radio)
- **BA/Marketing**, California State University, San Bernardino (1991 to 1994)
(Vice President – Students in Free Enterprise)
- **AA/Accounting**, Riverside Community College, Riverside, CA (1987-1991)

Kris Dick, Regional Operations Manager

**13369 Valley Blvd.
Fontana, CA 92335
(800) 411-0454
kdick@keefegroup.com**

**February 2009 - present
Regional Operations Manager
Keefe Group
Fontana, CA**

Currently oversees the operations for the Western Region of Keefe Group, which includes 7 states, 420 employees and 9 managers at 6 distribution centers and warehouses totaling over 235,000 square feet. This includes such large bed operations as the States of Arizona and Idaho, Los Angeles, Santa Clara and Riverside Counties. Kris ensures that daily production numbers are met and customer service level remains high.

January 2005 - February 2009, Warehouse Manager

**August 2004 - January 2005, Keefe Group Shipping Staff
Keefe Group
Fontana, CA**

Education

**U S Army
July 1998 - April 2004**

5.1.12 **Financial information and documentation to be included in Part III of your response in accordance with the Submittal Instructions.**

- 5.1.12.1 Dun and Bradstreet number
- 5.1.12.2 Federal Tax Identification Number
- 5.1.12.3 The last two - (2) years and current year interim:
Profit and Loss Statement
Balance Statement

Keefe Group has submitted the information requested in 5.12.1-5.12.3 in the Confidential Information part of this proposal as requested.

5.2 **REFERENCES**

Vendors should provide a minimum of three (3) references from similar projects performed for private, state and/or large local government clients within the last three years. **Vendors are required to submit Attachment D, Reference Form to the business references they list. The business references must submit the Reference Form directly to the Purchasing Division.** It is the vendor's responsibility to ensure that completed forms are received by the Purchasing Division on or before the proposal submission deadline for inclusion in the evaluation process. Business References not received, or not complete, may adversely affect the vendor's score in the evaluation process. The Purchasing Division may contact any or all business references for validation of information submitted.

- 5.2.1 Client name;
- 5.2.2 Project description;
- 5.2.3 Project dates (starting and ending);
- 5.2.4 Technical environment; (i.e., Software applications, Internet capabilities, Data communications, Network, Hardware)
- 5.2.5 Staff assigned to reference engagement that will be designated for work per this RFP; and
- 5.2.6 Client project manager name, telephone number, fax number and e-mail address.

Keefe Group welcomes the opportunity for the Participating States to hear from our valued customers, and has directed our references to submit Attachment D directly to the Purchasing Division as requested. The information requested in 5.2.1 to 5.2.6 for each of our submitted references can be found on the spreadsheet included on the next pages. Due to the nature of this RFP, we felt there was significant value in providing references from around the country.

5.3 SUBCONTRACTOR INFORMATION

5.3.1 Does this proposal include the use of subcontractors?

Yes _____ No _____ Unknown ___X___

If “Yes”, vendor must at the time of Participating Addendum:

5.3.1.1 Identify specific subcontractors by state and the specific requirements of this RFP for which each proposed subcontractor will perform services.

6. **COST**

Note: All Cost Proposals shall be submitted to the State as a separate, sealed package and clearly marked: “Cost Proposal in Response to RFP No. 1901”; please refer to the Submittal Instructions for further instruction.

The Vendor(s) shall report contract utilization and pay an administrative fee of .5% of the total kiosk spend to MCPA, paid quarterly. The MCPA/NASPO directors approved the level of the administration fee, and the fee is not negotiable. The administrative fee is to be paid quarterly within 60 days of the end of the quarter (See section 3.5 of the RFP for Reporting Schedule). In addition to the MCPA administrative fee, some NASPO and non-NASPO states may require that a fee be paid directly to the state on purchases made by procuring entities within that state. For all such requests, the fee level, payment method and schedule for such reports and payments shall be incorporated in a Participating Addendum that is made a part of the contracts. The Vendor(s) may adjust pricing accordingly for purchases made by procuring agencies within the jurisdiction of the state. Any such price adjustment shall not exceed the dollar value of the additional fee. All such agreements shall have no affect whatsoever on the MCPA fee or on the prices paid by the procuring agencies outside the jurisdiction of the state requesting the additional fee.

Vendors must provide detailed fixed prices for all costs associated with the responsibilities and related services. Clearly specify the nature of all expenses anticipated. Cost must be submitted on Attachment L. All pricing must be FOB destination regardless of state.

The State will not be liable for any costs in preparation of a proposal submitted in response to this RFP, in conduct of a presentation, or any other activities responding to this RFP.

Vendor shall report to the Lead State any price reduction, discount or other more favorable terms offered to any Purchasing Entity, and the awarded vendor agrees to negotiate in good faith to reestablish ceiling prices or other more favorable terms and conditions applicable to future orders.

Our Cost Proposal in response to this RFP has been included in a separate, sealed package as requested.

7. **PAYMENT**

Commission/Revenue

If applicable per proposal, describe the commissions that will be paid to the Department for the use of the system and music downloads.

7.1 Payment of commissions must be made on a monthly basis, to each participating state by check or money order. (See attachment L)

7.2 Additional details related to commission payments, due dates, penalties for late payment, etc. will be clarified in each participating addendum.

Purchase

- 7.3 Payment for the contracted service will be within 30 - 45 days upon receipt of invoice and the Customers approval.
- 7.4 Successful vendors will invoice the customer in each Participating State directly with that customer paying the vendor or their authorized distributors directly.
- 7.5 No additional payment will be authorized due to labor, materials, equipment, or any other extra costs necessary to meet codes, standards, and regulations.

8. SUBMITTAL INSTRUCTIONS

- 8.1 In lieu of a pre-proposal conference, the Purchasing Division will accept questions and/or comments in writing regarding this RFP.

The RFP Question Submittal Form is located on the Services RFP/RFQ Opportunities webpage at <http://purchasing.state.nv.us/services/sdocs.htm>. Select this RFP number and the "Question" link.

The deadline for submitting questions is April 5, 2011 at 2:00 p.m., Pacific Time. All questions and/or comments will be addressed in writing and responses e-mailed or faxed to prospective vendors on or about April 12, 2011.

- 8.2 RFP Timeline

<i>TASK</i>	<i>DATE/TIME</i>
Deadline for submitting questions	April 5, 2011 at 2:00 p.m.
Answers to all questions submitted available on or about	April 12, 2011
Deadline for submittal of Reference Questionnaires	April 29, 2011 @ 5:00 p.m.
<u>Deadline for submission and opening of proposals</u>	<u>May 4, 2011 @ 2:00 p.m.</u>
Evaluation period	May 5 ~ May 25
Vendor Presentations (approximate time frame)	May 24, 2011
Selection of vendor on or about	May 24, 2011

NOTES: *These dates represent a tentative schedule of events. The State reserves the right to modify these dates at any time.*

The State also reserves the right to forego vendor presentations and select vendor(s) based on the written proposals.

- 8.3 Proposal submission requirements:

- 8.3.1 Vendors shall submit their response in three (3) parts as designated below:

Part I: Technical Proposal

One (1) original marked "MASTER" sent to State of Nevada Purchasing Division.

Eight (8) identical copies ~ One (1) each of these copies to be sent to the sourcing team listed in **Section 8.3.3**.

One (1) identical copy on CD (**Note:** CD must be labeled accordingly and in a case.) sent to State of Nevada Purchasing Division.

Three (3) copies sent to State of Nevada Purchasing Division.

THE TECHNICAL PROPOSAL MUST INCLUDE A SEPARATE TAB/SECTION LABELED "**STATE DOCUMENTS**" WHICH SHALL INCLUDE:

- Page 1 of RFP
- All Amendments to the RFP
- All Attachments requiring signature
- Certificate of Insurance

Technical Proposal must not include cost or confidential information.

Technical Proposal shall be submitted to the State in a sealed package and be clearly marked:

"Technical Proposal in Response to RFP No. 1901"

Part II: Cost Proposal:

One (1) original marked "MASTER" sent to State of Nevada Purchasing Division.

One (1) identical copy on CD (**Note:** CD must be labeled accordingly and in a case.) State of Nevada Purchasing Division.

Three (3) copies sent to State of Nevada Purchasing Division.

Cost Proposal shall be submitted to the State in a sealed package and be clearly marked:

"Cost Proposal in Response to RFP No. 1901"

Part III: Confidential Information:

One (1) original marked "MASTER" sent to State of Nevada Purchasing Division; and

One (1) identical copy sent to State of Nevada Purchasing Division.

Confidential Information shall be submitted to the State in a sealed package and be clearly marked:

"Confidential Information in Response to RFP No. 1901"

If the separately sealed proposal, marked as required above, are enclosed in another container for mailing purposes, the outermost container must fully describe the contents of the package and be clearly marked:

REQUEST FOR PROPOSAL NO.: 1901

PROPOSAL OPENING DATE: May 4, 2011 @ 2:00 p.m.

FOR: Inmate Kiosks

- 8.3.2 **Proposal must be received at the address referenced below no later than 2:00 p.m. Pacific Time, May 4, 2011.** Proposals that do not arrive by proposal opening time and date WILL NOT BE ACCEPTED. Vendors may submit their proposal any time prior to the above stated deadline.

ALL PROPOSALS ARE TO BE DELIVERED TO EACH STATE NO LATER THAN MAY 4, 2011 @ 2:00 P.M. PACIFIC TIME (there will be no exceptions, if proposals are not received they will be deemed non responsive)

- 8.3.3 **One copy of each Technical Proposal (Part I) shall be submitted to:**

Nevada Evaluators

Dawn Rosenberg, Chief of Purchasing
Nevada Department of Corrections
5500 Snyder Ave
P.O. Box 7011
Carson City, NV 89702

Eric Graham,
Nevada Department of Corrections
5500 Snyder Ave
P.O. Box 7011
Carson City, NV 89702

Ohio Evaluators

Michelle Matheron, Data Administration Manager
Ohio Department of Rehabilitation and Correction Office of Administration
770 West Broad Street
Columbus, Ohio 43222

Virginia Evaluators

Cindy Sager
Department of Corrections
6900 Atmore Drive
Richmond, VA 23225

Lois Fegan
Department of Corrections
6900 Atmore Drive
Richmond, VA 23225

Wyoming Evaluators

Jamie L. Spezzano
WDOC Purchasing Manager
State of Wyoming, Department of Corrections
1934 Wyott Drive, Suite 100, Office A118

Cheyenne, WY 82002

Vince Bocchino
1934 Wyott Drive, Suite 100
Cheyenne, WY 82002

Kenneth Scott Abbott
1934 Wyott Drive, Suite 100
Cheyenne, WY 82002

Remaining proposals shall be submitted to:

State of Nevada, Purchasing Division
Ronda Miller, Services Purchasing
515 E. Musser Street, Suite 300
Carson City, NV 89701

- 8.4 The State will not be held responsible for proposal envelopes mishandled as a result of the envelope not being properly prepared. Facsimile, e-mail or telephone proposals will **NOT** be considered; however, at the State's discretion, the proposal may be submitted all or in part on electronic media, as requested within the RFP document. Proposal may be modified by facsimile, e-mail or written notice provided such notice is received prior to the opening of the proposals.
- 8.5 Although it is a public opening, only the names of the vendors submitting proposals will be announced NRS §333.335(6). Technical and cost details about proposals submitted will not be disclosed. Assistance for handicapped, blind or hearing-impaired persons who wish to attend the RFP opening is available. If special arrangements are necessary, please notify the Purchasing Division designee as soon as possible and at least two days in advance of the opening.
- 8.6 If discrepancies are found between two or more copies of the proposal, the master copy will provide the basis for resolving such discrepancies. If one copy of the proposal is not clearly marked "MASTER," the State may reject the proposal. However, the State may at its sole option, select one copy to be used as the master.
- 8.7 For ease of evaluation, the proposal should be presented in a format that corresponds to and references sections outlined within this RFP and should be presented in the same order. Responses to each section and subsection should be labeled so as to indicate which item is being addressed. Exceptions to this will be considered during the evaluation process.
- 8.8 If complete responses cannot be provided without referencing confidential information, such confidential information must be provided in accordance with submittal instructions and specific references made to the tab, page, section and/or paragraph where the confidential information can be located.
- 8.9 Proposals are to be prepared in such a way as to provide a straightforward, concise delineation of capabilities to satisfy the requirements of this RFP. Emphasis should be concentrated on conformance to the RFP instructions, responsiveness to the RFP

requirements, and on completeness and clarity of content. Expensive bindings, colored displays, promotional materials, and unnecessarily elaborate responses beyond what is sufficient to present a complete and effective response to this RFP are not necessary or desired and may be construed as an indication of the proposer's lack of environmental and cost consciousness. Unless specifically requested in this RFP, elaborate artwork, corporate brochures, lengthy narratives, expensive paper, specialized binding, and other extraneous presentation materials are neither necessary nor desired.

The State of Nevada, in its continuing efforts to reduce solid waste and to further recycling efforts requests that proposals, to the extent possible and practical:

- Be submitted on recycled paper.
 - Not include pages of unnecessary advertising;
 - Be made on both sides of each sheet of paper; and
 - Be contained in re-usable binders rather than with spiral or glued bindings.
- 8.10 Descriptions on how any and all equipment and/or services will be used to meet the requirements of this RFP shall be given, in detail, along with any additional information documents that are appropriately marked.
- 8.11 The proposal must be signed by the individual(s) legally authorized to bind the vendor, see NRS §333.337.
- 8.12 For ease of responding to the RFP, vendors are encouraged, but not required, to request an electronic copy of the RFP. Electronic copies are available in the following formats: Word 2003 via e-mail, diskette, or on the State Purchasing Division's website in PDF or EXE format at <http://purchasing.state.nv.us>. When requesting an RFP via e-mail or diskette, vendors should contact the Purchasing Division for assistance. In the event vendors choose to receive the RFP on diskette, the vendor will be responsible for providing a blank 3.5" formatted diskette; unless vendors provide a Federal Express, Airborne Express, etc. account number and appropriate return materials, the diskette will be returned by first class U.S. mail.
- 8.13 Vendors utilizing an electronic copy of the RFP in order to prepare their proposal should place their written response in *an easily distinguishable font* immediately following the applicable question.
- 8.14 ***For purposes of addressing questions concerning this RFP, the sole contact will be the Purchasing Division. Upon issuance of this RFP, other employees and representatives of the agencies identified in the RFP will not answer questions or otherwise discuss the contents of this RFP with any prospective vendors or their representatives. Failure to observe this restriction may result in disqualification of any subsequent proposal NAC §333.155(3).*** This restriction does not preclude discussions between affected parties for the purpose of conducting business unrelated to this procurement.
- 8.15 Vendor who believes proposal requirements or specifications are unnecessarily restrictive or limit competition may submit a request for administrative review, in writing, to the Purchasing Division. To be considered, a request for review must be **received** no later than the deadline for submission of questions.

The Purchasing Division shall promptly respond in writing to each written review request, and where appropriate, issue all revisions, substitutions or clarifications through a written amendment to the RFP.

Administrative review of technical or contractual requirements shall include the reason for the request, supported by factual information, and any proposed changes to the requirements.

- 8.16 If a vendor changes any material RFP language, vendor's response may be deemed non-responsive. NRS §333.311.
- 8.17 Vendors are cautioned that some services may contain licensing requirement(s). Vendors shall be proactive in verification of these requirements prior to proposal submittal. Proposals, which do not contain the requisite licensure, may be deemed non-responsive. However, this does not negate any applicable Nevada Revised Statute (NRS) requirements.

9. PROPOSAL EVALUATION AND AWARD PROCESS

9.1 Proposals shall be consistently evaluated and scored in accordance with NRS §333.335(3) based upon the following criteria:

- Demonstrated competence/experience in performance of comparable engagements
 - Technological merits
 - Environmental and accessibility merits
 - Ability to service the Contract.
 - All-encompassing approach to proposed equipment, software and services
 - Conformance with the requirements, terms and conditions of this RFP
 - Pricing
- Presentations – Following the evaluation and scoring process specified above, the State may require vendors to make a presentation of their proposal to the evaluation committee or other State staff, as applicable. The State, at its option, may limit participation in vendor presentations up to the four (4) highest ranking vendors. NOTE: The State reserves the right to forego vendor presentations and select vendor(s) based on the written proposal.

Note: Financial stability will be scored on a pass/fail basis

Proposals shall be kept confidential until a contract is awarded.

9.2 The evaluation committee may also contact the references provided in response to the Section identified as Company Background and References; contact any vendor to clarify any response; contact any current users of a vendor's services; solicit information from any available source concerning any aspect of a proposal; and seek and review any other information deemed pertinent to the evaluation process. The evaluation committee shall not be obligated to accept the lowest priced proposal, but shall make an award in the best interests of the State of Nevada NRS § 333.335(5)

- 9.3 Each vendor must include in its proposal a complete disclosure of any alleged significant prior or ongoing contract failures, contract breaches, any civil or criminal litigation or investigations pending which involves the vendor or in which the vendor has been judged guilty or liable. Failure to comply with the terms of this provision may disqualify any proposal. The State reserves the right to reject any proposal based upon the vendor's prior history with the State or with any other party, which documents, without limitation, unsatisfactory performance, adversarial or contentious demeanor, significant failure(s) to meet contract milestones or other contractual failures. See generally, NRS §333.335.
- 9.4 Clarification discussions may, at the State's sole option, be conducted with vendors who submit proposals determined to be acceptable and competitive NAC §333.165. Vendors shall be accorded fair and equal treatment with respect to any opportunity for discussion and/or written revisions of proposals. Such revisions may be permitted after submissions and prior to award for the purpose of obtaining best and final offers. In conducting discussions, there shall be no disclosure of any information derived from proposals submitted by competing vendors.
- 9.5 A Notification of Intent to Award shall be issued in accordance with NAC §333.170. Any award is contingent upon the successful negotiation of final contract terms and upon approval of the Board of Examiners, when required. Negotiations shall be confidential and not subject to disclosure to competing vendors unless and until an agreement is reached. If contract negotiations cannot be concluded successfully, the State upon written notice to all vendors may negotiate a contract with the next highest scoring vendor or withdraw the RFP.
- 9.6 Any contract resulting from this RFP shall not be effective unless and until approved by the Nevada State Board of Examiners (NRS 284.173).

10. **TERMS, CONDITIONS AND EXCEPTIONS**

- 10.1 Performance of vendors will be rated semi-annually following contract award and then annually for the term of the contract by the using State agency in six categories: Customer service; timeliness; quality; technology; flexibility; and pricing. Vendors will be notified in writing of their rating.
- 10.2 In accordance with Nevada Revised Statute 333.336, if a vendor submitting a proposal in response to this solicitation is a resident of another state, and with respect to contracts awarded by that state, applies to vendors who are residents of that state a preference, which is not afforded to vendors or contractors who are residents of the State of Nevada, the State of Nevada, Purchasing Division shall, insofar as is practicable, increase the out of state vendor's proposal by an amount that is substantially equivalent to the preference that the other state of which the vendor is a resident denies to vendors or contractors who are residents of the State of Nevada.
- 10.3 This procurement is being conducted in accordance with NRS chapter 333 and NAC chapter 333.
- 10.4 The State reserves the right to alter, amend, or modify any provisions of this RFP, or to withdraw this RFP, at any time prior to the award of a contract pursuant hereto, if it is in the best interest of the State to do so.

- 10.5 The State reserves the right to waive informalities and minor irregularities in proposals received.
- 10.6 The State reserves the right to reject any or all proposals received prior to Contract award (NRS §333.350).
- 10.7 The State shall not be obligated to accept the lowest priced proposal, but will make an award in the best interests of the State of Nevada after all factors have been evaluated (NRS §333.335).
- 10.8 Any irregularities or lack of clarity in the RFP should be brought to the Purchasing Division designee's attention as soon as possible so that corrective addenda may be furnished to prospective vendors.
- 10.9 Proposals must include any and all proposed terms and conditions, including, without limitation, written warranties, maintenance/service agreements, license agreements, lease purchase agreements and the vendor's standard contract language. The omission of these documents renders a proposal non-responsive.
- 10.10 Alterations, modifications or variations to a proposal may not be considered unless authorized by the RFP or by addendum or amendment.
- 10.11 Proposals which appear unrealistic in the terms of technical commitments, lack of technical competence, or are indicative of failure to comprehend the complexity and risk of this Contract, may be rejected.
- 10.12 Proposals from employees of the State of Nevada will be considered in as much as they do not conflict with the State Administrative Manual, NRS Chapter §281 and NRS Chapter §284.
- 10.13 Proposals may be withdrawn by written or facsimile notice received prior to the proposal opening time. Withdrawals received after the proposal opening time will not be considered except as authorized by NRS §333.350(3).
- 10.14 The price and amount of this proposal must have been arrived at independently and without consultation, communication, agreement or disclosure with or to any other contractor, vendor or prospective vendor. Collaboration among competing vendors about potential proposals submitted pursuant to this RFP is prohibited and may disqualify the vendor.
- 10.15 No attempt may be made at any time to induce any firm or person to refrain from submitting a proposal or to submit any intentionally high or noncompetitive proposal. All proposals must be made in good faith and without collusion.
- 10.16 Prices offered by vendors in their proposals are an irrevocable offer for the term of the Contract and any contract extensions. The awarded vendor agrees to provide the purchased services at the costs, rates and fees as set forth in their proposal in response to this RFP. No other costs, rates or fees shall be payable to the awarded vendor for implementation of their proposal.

- 10.17 The State is not liable for any costs incurred by vendors prior to entering into a formal contract. Costs of developing the proposal or any other such expenses incurred by the vendor in responding to the RFP, are entirely the responsibility of the vendor, and shall not be reimbursed in any manner by the State.
- 10.18 All proposals submitted become the property of the State, selection or rejection does not affect this right; proposals will be returned only at the State's option and at the vendor's request and expense. The master technical proposal, the master cost proposal and Confidential Information of each response shall be retained for official files. Only the master technical and master cost will become public record after the award of a contract. The failure to separately package and clearly mark Part IV – which contains Confidential Information, Trade Secrets and/or Proprietary Information shall constitute a complete waiver of any and all claims for damages caused by release of the information by the State.
- 10.19 A proposal submitted in response to this RFP must identify any subcontractors, and outline the contractual relationship between the awarded vendor and each subcontractor. An official of each proposed subcontractor must sign, and include as part of the proposal submitted in response to this RFP, a statement to the effect that the subcontractor has read and will agree to abide by the awarded vendor's obligations.
- 10.20 The awarded vendor will be the sole point of contract responsibility. The State will look solely to the awarded vendor for the performance of all contractual obligations which may result from an award based on this RFP, and the awarded vendor shall not be relieved for the non-performance of any or all subcontractors.
- 10.21 The awarded vendor must maintain, for the duration of its contract, insurance coverages as set forth in the Insurance Schedule of the Contract form appended to this RFP. Work on the Contract shall not begin until after the awarded vendor has submitted acceptable evidence of the required insurance coverages. Failure to maintain any required insurance coverage or acceptable alternative method of insurance will be deemed a breach of Contract.
- 10.22 Notwithstanding any other requirement of this section, the State reserves the right to consider reasonable alternative methods of insuring the Contract in lieu of the insurance policies required by the below-stated Insurance Schedule. It will be the awarded vendor's responsibility to recommend to the State alternative methods of insuring the Contract. Any alternatives proposed by a vendor should be accompanied by a detailed explanation regarding the vendor's inability to obtain insurance coverage as described below. The State shall be the sole and final judge as to the adequacy of any substitute form of insurance coverage.
- 10.23 Each vendor must disclose any existing or potential conflict of interest relative to the performance of the contractual services resulting from this RFP. Any such relationship that might be perceived or represented as a conflict should be disclosed. By submitting a proposal in response to this RFP, vendors affirm that they have not given, nor intend to give at any time hereafter, any economic opportunity, future employment, gift, loan, gratuity, special discount, trip, favor, or service to a public servant or any employee or representative of same, in connection with this procurement. Any attempt to intentionally or unintentionally conceal or obfuscate a conflict of interest will automatically result in the disqualification of a vendor's proposal. An award will not be made where a conflict

of interest exists. The State will determine whether a conflict of interest exists and whether it may reflect negatively on the State's selection of a vendor. The State reserves the right to disqualify any vendor on the grounds of actual or apparent conflict of interest.

- 10.24 The State will not be liable for Federal, State, or Local excise taxes NRS §372.325.
- 10.25 Attachment B of this RFP shall constitute an agreement to all terms and conditions specified in the RFP, including, without limitation, the Attachment C contract form and all terms and conditions therein, except such terms and conditions that the vendor expressly excludes. Exceptions will be taken into consideration as part of the evaluation process.
- 10.26 The State reserves the right to negotiate final contract terms with any vendor selected NAC §333.170. The contract between the parties will consist of the RFP together with any modifications thereto, and the awarded vendor's proposal, together with any modifications and clarifications thereto that are submitted at the request of the State during the evaluation and negotiation process. In the event of any conflict or contradiction between or among these documents, the documents shall control in the following order of precedence: the final executed contract, the RFP, any modifications and clarifications to the awarded vendor's proposal, and the awarded vendor's proposal. Specific exceptions to this general rule may be noted in the final executed contract.
- 10.27 Vendor understands and acknowledges that the representations above are material and important, and will be relied on by the State in evaluation of the proposal. Any vendor misrepresentation shall be treated as fraudulent concealment from the State of the true facts relating to the proposal.
- 10.28 No announcement concerning the award of a contract as a result of this RFP can be made without the prior written approval of the State.
- 10.29 The Nevada Attorney General will not render any type of legal opinion regarding this transaction.
- 10.30 Any unsuccessful vendor may file an appeal in strict compliance with NRS 333.370 and chapter 333 of the Nevada Administrative Code.
- 10.31 Local governments (as defined in NRS §332.015) are intended third party beneficiaries of any contract resulting from this RFP and any local government may join or use any contract resulting from this RFP subject to all terms and conditions thereof pursuant to NRS §332.195. The State is not liable for the obligations of any local government which joins or uses any contract resulting from this RFP.
- 10.32 Any person who requests or receives a Federal contract, grant, loan or cooperative agreement shall file with the using agency a certification that the person making the declaration has not made, and will not make, any payment prohibited by subsection (a) of 31 U.S.C. §1352.

11. SUBMISSION CHECKLIST

This checklist is provided for vendor’s convenience only and identifies documents that must be submitted with each package in order to be considered responsive. Any proposals received without these requisite documents may be deemed non-responsive and not considered for contract award.

Part I TECHNICAL PROPOSAL:

Required number of Technical proposals (per Submittal Instructions) **Completed**
_____X_____

Part II COST PROPOSAL:

Required number of Cost proposals (per Submittal Instructions) _____X_____

Part III STATE DOCUMENTS:

Required Forms to be submitted labeled “State Documents”:

- Page 1 of the RFP completed _____X_____
- All Amendments completed and signed _____X_____
- Primary Vendor Attachments A & B signed _____X_____
- Primary Vendor Information provided _____X_____
- Certificate of Insurance – Primary vendor only _____X_____

Part IV CONFIDENTIAL INFORMATION:

- Required number of Confidential Information (per Submittal Instructions and defined in Acronyms/Definitions) _____X_____
- Financial Information _____

REMINDERS:

1. Send out Reference forms for Primary Vendor (with Part A completed) _____X_____
2. Send out Reference forms for Subcontractors (with Part A completed) (if applicable) _____X_____

6. **COST**

Note: All Cost Proposals shall be submitted to the State as a separate, sealed package and clearly marked: “Cost Proposal in Response to RFP No. 1901”, please refer to the Submittal Instructions for further instruction.

The Vendor(s) shall report contract utilization and pay an administrative fee of .5% of the total kiosk spend to MCPA, paid quarterly. The MCPA/NASPO directors approved the level of the administration fee, and the fee is not negotiable. The administrative fee is to be paid quarterly within 60 days of the end of the quarter (See section 3.5 of the RFP for Reporting Schedule). In addition to the MCPA administrative fee, some NASPO and non-NASPO states may require that a fee be paid directly to the state on purchases made by procuring entities within that state. For all such requests, the fee level, payment method and schedule for such reports and payments shall be incorporated in a Participating Addendum that is made a part of the contracts. The Vendor(s) may adjust pricing accordingly for purchases made by procuring agencies within the jurisdiction of the state. Any such price adjustment shall not exceed the dollar value of the additional fee. All such agreements shall have no affect whatsoever on the MCPA fee or on the prices paid by the procuring agencies outside the jurisdiction of the state requesting the additional fee.

Vendors must provide detailed fixed prices for all costs associated with the responsibilities and related services. Clearly specify the nature of all expenses anticipated. Cost must be submitted on Attachment L. All pricing must be FOB destination regardless of state.

The State will not be liable for any costs in preparation of a proposal submitted in response to this RFP, in conduct of a presentation, or any other activities responding to this RFP.

Vendor shall report to the Lead State any price reduction, discount or other more favorable terms offered to any Purchasing Entity, and the awarded vendor agrees to negotiate in good faith to reestablish ceiling prices or other more favorable terms and conditions applicable to future orders.

As the nation's leading commissary services and technology provider to the corrections market, our experience with both the State of Nevada and across the country allows us to offer the absolute best combination of products, services and technology.

Keefe is the only company to design, assemble and support our own kiosks and write, support and maintain our own offender banking, inventory and commissary services software. Our Edge Housing Unit kiosk is the leading self service offender ordering system in the country. Keefe currently has deployed 850 kiosks at over 100 correctional facilities.

Additionally our MP3 program is the only proven correctional MP3 program currently operating in 8 state-wide DOC's with an additional two DOC awards currently starting. To date, we have delivered more than 2 million songs successfully to thousands of inmates nationwide. Our Secure Deposit and Email programs are proven and currently deployed throughout the country.

Below, Keefe Group has submitted two **NO COST** proposals in exchange for our industry leading services. Both proposals include hardware, software and installation of the kiosks offered. Keefe will be responsible for the replacement or repair of kiosks, servers and/or software. Additionally, there are no costs for 24 hour support, ongoing maintenance or software customizations that with other vendors may otherwise cost as much as \$200 per hour. We have provided summaries of both proposals, and have completed Attachment L, below.

In addition to providing hardware, software, installation and services at no charge to the state, our proposal will generate a substantial increase in revenue for the department and continue to build on what is already a successful partnership. The benefits to a proven turnkey solution are endless.

While the concept of our **NO COST** offers can be applied to any participating state, the cost and commission details of the two programs below are specific to the State of Nevada. Because each state is different in size and physical layout, has different existing service levels and are interested in implementing varying combinations of our services we respectfully reserve the right to negotiate these details with each of them individually through the outlined amendment process.

PROPOSAL ONE

		State	Nevada	Participating States
		No. of Inmates (Currently Incarcerated)	13,000	
Kiosks Requirements				
	3.1.1.1	Turnkey Kiosks		
		No. of Kiosks	100%	100%
		Lease, Purchase or No Cost	NO COST TO DOC	NO COST TO DOC
	3.1.1.2	Stand Alone Kiosk		
		No. of Kiosks	100%	100%
		Lease, Purchase or No Cost	NO COST TO DOC	NO COST TO DOC
	3.1.1.3	Outside Kiosk		
		No. of Kiosks	100%	100%
		Lease, Purchase or No Cost	NO COST TO DOC	NO COST TO DOC
	3.1.1.4	Hardware Only Kiosk		
		Specify type proposing:		
		No. of Kiosks	N/A	N/A
		Lease, Purchase or No Cost	N/A	N/A
	NOTE:	If Kiosk is leased, include all costs associated to include maintenance.		

Under Proposal One, Keefe has offered the State of Nevada a turnkey solution including 220 of our Edge Housing Unit kiosks and 8 of our Secure Deposit Lobby kiosks at no cost to the state. We believe 220 kiosks is likely more than needed to adequately address the needs of the state, but as a responsible vendor want to ensure that we accounted for physical layout or other variables that might increase the quantity needed.

The Edge Housing Unit kiosks will allow inmates to place and review commissary orders, download MP3 songs, receive and send Email/Secure Messaging, review account history and phone usage, request appointments and send grievances. The Edge Housing Unit kiosks are also used for video visitation. Of the 220 units a certain number could be installed in areas dedicated specifically to video visitation should the department wish.

The Secure Deposits kiosks will allow inmate family members and friends another avenue to deposit money to an inmate account. The eight (8) Secure Deposit Lobby kiosks will be located in the lobbies at each of your main correctional locations. Keefe will also provide a lock box program, website and 24 hour, toll free number to deposit funds to an inmate's account.

		State	Nevada	Participating States
3.2	Technical Environment			
		3.2.1	Kiosk Application: User Fees Applied Per Service if applicable	
			Email/Secure Messaging	NO COST TO DOC -- SEE BELOW
			Inmate Banking (deposits)	NO COST TO DOC -- SEE BELOW
			Inmate Grievances	NO COST TO DOC
			Video Visitation	NO COST TO DOC -- SEE BELOW
			Inmate Scheduling	NO COST TO DOC
			MP3 Download Information	NO COST TO DOC
			MP3 Purchase Music	NO COST TO DOC -- SEE BELOW
			Phone Time Usage	NO COST TO DOC -- SEE BELOW
			Application Architecture	NO COST TO DOC
			Interfacing	NO COST TO DOC
			Communications	NO COST TO DOC
			Scalability (No. of inmates per Kiosk; Maximum 250)	100
			Other Applications (Describe in detail)	100

In addition to the hardware and software needed to implement the above listed applications, Keefe Group is proposing to provide our industry leading services. As a leader in the industry, we can provide our partners with all of these services and technologies. Having one point of contact streamlines daily operations and communication while also empowering future creation.

- **Email/Secure Messaging:** The below proposed fee structure outlines the prices that inmates and their family and friends would pay for Email/Secure Messaging. There is no cost to the Department of Corrections. Additionally, a commissionable return to the department on transactions has been outlined later in this document.

Fees --

Email Package (# of Messages in Plan)

1	\$0.40
5	\$1.75
20	\$5.99
40	\$9.99

Photo Package (# of Photos in Plan)

1	\$0.40
5	\$1.75
20	\$5.99
40	\$9.99

- **Inmate Banking (deposits):** The below proposed fee structure outlines the prices that inmate family and friends would pay to deposit money. There is no cost to the Department of Corrections. Additionally, a commissionable return to the department on transactions has been outlined later in this document.

DEPOSIT SERVICES FEE STRUCTURE					
Gross Amount Deposited	Web	Phone	Credit at Lobby	Cash	Lockbox Fee
\$0.01 - \$19.99	\$3.95	\$4.95	\$3.95	\$4.00	\$0.00
\$20.00 - \$99.99	\$6.95	\$7.95	\$6.95	\$4.00	\$0.00
\$100.00 - \$199.99	\$8.95	\$9.95	\$8.95	\$4.00	\$0.00
\$200.00 - \$300.00	\$10.95	\$11.95	\$10.95	\$4.00	\$0.00

- **Video Visitation:** Keefe Group has proposed a fee of \$9.95 per 20 minute visitation session. This fee would be paid by inmate family and friends. There is no cost to the Department of Corrections. Additionally, a commission to be paid back to the department on transactions has been outlined later in this document.
- **MP3 Program:** Keefe Group has listed the sale prices to inmates and their family and friends for our MP3 players and songs in the related equipment section outlined later in this document. There is no cost to the Department of Corrections. Keefe asks that the department not mark up the sale price of the MP3 player and songs, but has accounted for a commission to be paid back to the department on both. The commission is outlined later in this document.
- **Phone Usage:** The Edge™ kiosk phone management feature allows the offender to browse both phone call history and call charge history. The feature also allows the offender to request the addition of personal allowed numbers (PAN) to his or her caller list. If Keefe's inmate banking software is being used and the state is interested, we will request the phone vendor provide an integration to implement Direct Link Trust (DLT). DLT allows inmates to access their trust account to fund calling in real time. In Nevada specifically, CenturyLink/IC Solutions has agreed to provide the necessary integration for DLT should the state wish to use our inmate banking software. We have also discussed with CenturyLink /IC Solutions the ability to provide Nevada phone-order entry. This option can be used for all inmates, but has direct benefits to inmates in restricted areas. This method, if implemented will continue to uphold all ordering restrictions, and provide inmates the option of checking account balances and recent deposits.

			State	Nevada	Participating States
		3.2.2	Software Architecture		
			Specify applications proposing:	NO COST TO DOC -- SEE BELOW	NO COST TO DOC -- SEE BELOW
		3.2.3	System Architecture		
			Specify items proposing	NO COST TO DOC -- SEE BELOW	NO COST TO DOC -- SEE BELOW
		3.2.4	Customer Interaction Messages		
			Specify applications proposing:	NO COST TO DOC -- SEE BELOW	NO COST TO DOC -- SEE BELOW
		3.2.5	Remote Management		
			Specify applications proposing:	NO COST TO DOC -- SEE BELOW	NO COST TO DOC -- SEE BELOW
		3.2.6	Software Provisions		
			Specify applications proposing:	NO COST TO DOC -- SEE BELOW	NO COST TO DOC -- SEE BELOW
		3.2.7	Hardware Requirements		
			Specify items proposing	NO COST TO DOC -- SEE BELOW	NO COST TO DOC -- SEE BELOW
			Monitor		

As your partner, we make it our mission to understand the needs of your facilities and provide you with the easy-to-use solutions. We have a full-time software development team, completely dedicated to product advancement and are willing to discuss the specific needs of the state as they arise.

			State	Nevada	Participating States
3.3	Security Requirements				
			Describe all cost associated with this section.	NO COST TO DOC	NO COST TO DOC
3.4	Maintenance/ Service				
		3.4.1	Software Modification/Release Mgt		
				NO COST TO DOC -- SEE BELOW	NO COST TO DOC -- SEE BELOW
3.5	Reporting				
			List any cost associated with this section. If none, list N/A	NO COST TO DOC	NO COST TO DOC
3.6	Training and Support				
			Describe all cost associated with this section.	NO COST TO DOC -- SEE BELOW	NO COST TO DOC -- SEE BELOW
3.7	System Warranty				
			List any cost associated with this section. If none, list N/A.	NO COST TO DOC -- SEE BELOW	NO COST TO DOC -- SEE BELOW
3.8	DRC Security Requirement				
			Not Applicable		
3.9	Optional/Other Services				
			Describe all cost associated with this section.	NO COST TO DOC	NO COST TO DOC
3.10	Documentation				
			List any cost associated with this section. If none, list N/A.	NO COST TO DOC	NO COST TO DOC

Keefe Group proposes to provide all hardware and all wiring and installation of inmate ordering kiosks at NO COST to Nevada Department of Corrections. Keefe will provide all software, on-going training and 24-hour 365 days a year support.

Keefe Group has a dedicated Technical Specialist within our region and employs an entire department of technicians at our corporate office. We also have a dedicated Vice President and Account Manager based out of our Reno office to handle this

contract. Our turnkey solution offers you one point of contact should there be an issue with any of these services. Any and all upgrades of hardware and software and additional training to facility staff will be provided by Keefe Group at no cost to the State for the life of the Agreement. We have a strong working relationship with Shawntec Communications, Inc. Shawntec currently has employees cleared by Nevada DOC and already working in the field. This relationship provides us additional options should a need arise.

Keefe Group has no hidden fees or maintenance costs, no processing fees, and no installation fees.

Commission	DRC Commission		
	Commissary Commission		3%
	Email/Secure Messaging		\$0.20
	Inmate Banking (deposits)		\$1.00
	MP3 Player Sales		6.0%
	MP3 Song Sales		\$0.25
	Video Visitation		20.00%

Under Proposal One:

- The Nevada Department of Corrections would continue to utilize Keefe as their primary commissary vendor, purchasing existing items and considering Keefe for new items, for the length of this partnership. Keefe offers to **maintain existing product pricing and** offers the department **an additional three (3) percent commission** on total commissary sales. Commission will be based on total dollars of commissary product purchased statewide and can be remitted on a monthly, quarterly or annual basis. **Keefe will not charge the inmate or the department any fees for placing commissary orders at the kiosk.** Keefe believes this offer will generate significant revenue for the department. **This 3% commission is only offered in Proposal One.**
- Keefe offers the Nevada Department of Corrections a \$.20 commission on each Email/Secure Messaging and Photo transaction. **This is \$.10 per transaction more than Proposal Two.**
- Keefe offers the Nevada Department of Corrections a \$1.00 commission on each Secure Deposits transaction, with the exception of those made through our lock box option. For convenience sake, Keefe has offered our lock box service at **no charge** to the inmate family and friends. Should the department wish to receive a commission on this service, Keefe will adjust pricing accordingly.
- Keefe offers the Nevada Department of Corrections a six percent (6%) commission on each MP3 player sold.

- Keefe offers the Nevada Department of Corrections \$.25 on each MP3 song downloaded. **This is \$.05 per transaction more than Proposal Two.**
- Keefe offers the Nevada Department of Corrections 20% of all video visitation revenue.

Should the department wish to negotiate rates and/or commissions, Keefe is willing to discuss.

		State	Nevada	Participating States
Related Equipment				
		MP3 MINI MAXX PLAYER	\$49.99	
		MP3 MAXX PLAYER (4GB)	\$79.95	
		MP3 MAXX PLAYER (8GB)	\$99.95	
		MP3 MAXX TOUCH PLAYER (4GB)	\$99.95	
		MP3 MAXX TOUCH PLAYER (8 GB)	\$129.95	
		MP3 MAXX SLIDE PLAYER (8 GB)	\$159.95	
		MP3 MAXX SLIDE PLAYER (16 GB)	\$199.95	
		MP3 SONGS	\$1.80	

Keefe offers a wide selection of player options to the inmate population. We are the only proven MP3 provider, with eight (8) existing state DOC customers and another two (2) in implementation stage. Our players have been designed specifically for use in the correctional environment and therefore built to withstand the rigors associated. We have included samples of our Maxx MP3 player, along with a keyboard and the life skills programs on CD in all of the technical responses. Additionally, our MP3 player allows inmates to choose songs from the player rather than having to search from the kiosk. The significant additional time required for inmates to search from the kiosk (as opposed to on the player on their own time) can create disruption within the facility as well as puts an additional burden on the kiosk itself. Keefe's MP3 accessories include, but are not limited to, clear plastic keyboards and armbands.

PROPOSAL TWO

			State	Nevada	Participating States
			No. of Inmates (Currently Incarcerated)	13,000	
3.1	Kiosks Requirements				
		3.1.1.1	Turnkey Kiosks		
			No. of Kiosks	100%	100%
			Lease, Purchase or No Cost	NO COST TO DOC	NO COST TO DOC
		3.1.1.2	Stand Alone Kiosk		
			No. of Kiosks	100%	100%
			Lease, Purchase or No Cost	NO COST TO DOC	NO COST TO DOC
		3.1.1.3	Outside Kiosk		
			No. of Kiosks	100%	100%
			Lease, Purchase or No Cost	NO COST TO DOC	NO COST TO DOC
		3.1.1.4	Hardware Only Kiosk		
			Specify type proposing:		
			No. of Kiosks	N/A	N/A
			Lease, Purchase or No Cost	N/A	N/A
		NOTE:	If Kiosk is leased, include all costs associated to include maintenance.		

Under Proposal Two, Keefe has offered the State of Nevada a turnkey solution that includes 220 of our Edge Housing Unit kiosks and 8 of our Secure Deposit Lobby kiosks at no cost to the state. We believe 220 kiosks is more than needed to adequately address the needs of the state, but wanted to ensure that we were conservative in case physical layout or other variables increased the quantity needed.

The Edge Housing Unit kiosks will allow inmates to place and review commissary orders, download MP3 songs, receive and send Email/Secure Messaging, review account history and phone usage, request appointments and send grievances. The Edge Housing Unit kiosks are also used for video visitation. Of the 220 units a certain number could be installed in areas dedicated specifically to video visitation should the department wish.

The Secure Deposits kiosks will allow inmate family members and friends another avenue to deposit money to their loved ones inmate trust. The eight (8) Secure Deposit Lobby kiosks will be located in the lobbies at each of your main correctional locations. Keefe will also provide a lock box program, website and toll free number to deposit funds to an inmate's account.

			State	Nevada	Participating States
3.2	Technical Environment				
		3.2.1	Kiosk Application: User Fees Applied Per Service if applicable		
			Email/Secure Messaging	NO COST TO DOC -- SEE BELOW	
			Inmate Banking (deposits)	NO COST TO DOC -- SEE BELOW	
			Inmate Grievances	NO COST TO DOC	
			Video Visitation	NO COST TO DOC -- SEE BELOW	
			Inmate Scheduling	NO COST TO DOC	
			MP3 Download Information	NO COST TO DOC	
			MP3 Purchase Music	NO COST TO DOC -- SEE BELOW	
			Phone Time Usage	NO COST TO DOC -- SEE BELOW	
			Application Architecture	NO COST TO DOC	
			Interfacing	NO COST TO DOC	
			Communications	NO COST TO DOC	
			Scalability (No. of inmates per Kiosk; Maximum 250)	100	
			Other Applications (Describe in detail)		

In addition to the hardware and software needed to implement the above listed applications, Keefe Group is proposing to provide our industry leading services. As a leader in the industry, we can provide the department with all of these services and technologies. Having one point of contact streamlines daily operations and communication while also empowering future creation.

- **Email/Secure Messaging:** The below proposed fee structure outlines the prices that inmates and their family and friends would pay for Email/Secure Messaging. There is no cost to the Department of Corrections. Additionally, a commission to be paid back to the department on transactions has been outlined later in this document.

Fees --			
<u>Email Package (# of Messages in Plan)</u>		<u>Photo Package (# of Photos in Plan)</u>	
1	\$0.40	1	\$0.40
5	\$1.75	5	\$1.75
20	\$5.99	20	\$5.99
40	\$9.99	40	\$9.99

- **Inmate Banking (deposits):** The below proposed fee structure outlines the prices that inmate family and friends would pay to deposit money. There is no cost to the Department of Corrections. Additionally, a commission to be paid back to the department on transactions has been outlined later in this document.

DEPOSIT SERVICES FEE STRUCTURE					
Gross Amount Deposited	Web	Phone	Credit at Lobby	Cash	Lockbox Fee
\$0.01 - \$19.99	\$3.95	\$4.95	\$3.95	\$4.00	\$0.00
\$20.00 - \$99.99	\$6.95	\$7.95	\$6.95	\$4.00	\$0.00
\$100.00 - \$199.99	\$8.95	\$9.95	\$8.95	\$4.00	\$0.00
\$200.00 - \$300.00	\$10.95	\$11.95	\$10.95	\$4.00	\$0.00

- **Video Visitation:** Keefe Group has proposed a fee of \$9.95 per 20 minute visitation session. This fee would be paid by inmate family and friends. There is no cost to the Department of Corrections. Additionally, a commission to be paid back to the department on transactions has been outlined later in this document.
- **MP3 Program:** Keefe Group has listed the sale prices to inmates and their family and friends for our MP3 players and songs in the related equipment section outlined later in this document. There is no cost to the Department of Corrections. Keefe asks that the department not mark up the sale price of the MP3 player and songs, but has accounted for a commission to be paid back to the department on both. The commission is outlined later in this document.
- **Phone Usage:** The Edge™ kiosk phone management feature allows the offender to browse both phone call history and call charge history. The feature also allows the offender to request the addition of personal allowed numbers (PAN) to his or her caller list. If Keefe's inmate banking software is being used and the state is interested, we will request the phone vendor provide an integration to implement Direct Link Trust (DLT). DLT allows inmates to access their trust account to fund calling in real time. In Nevada specifically, CenturyLink/IC Solutions has agreed to provide the necessary integration for DLT should the state wish to use our inmate banking software. We have also discussed with CenturyLink/IC Solutions the ability to provide Nevada phone-order entry. This option can be used for all inmates, but has direct benefits to inmates in restricted areas. This method, if implemented will continue to uphold all ordering restrictions, and provide inmates the option of checking account balances and recent deposits.

		State	Nevada	Participating States
		3.2.3	System Architecture	
			Specify items proposing	NO COST TO DOC- SEE BELOW
		3.2.4	Customer Interaction Messages	
			Specify applications proposing:	NO COST TO DOC -- SEE BELOW
		3.2.5	Remote Management	
			Specify applications proposing:	NO COST TO DOC -- SEE BELOW
		3.2.6	Software Provisions	
			Specify applications proposing:	NO COST TO DOC -- SEE BELOW
		3.2.7	Hardware Requirements	
			Specify items proposing	NO COST TO DOC -- SEE BELOW
			Monitor	

As your partner, we make it our mission to understand the needs of your facilities and provide you with the easy-to-use solutions. Keefe's full-time software development team is completely dedicated to product advancement. If selected, Keefe is committed to remaining flexible throughout our partnership and are willing to discuss the specific needs of the state as they arise.

			State	Nevada	Participating States
3.3	Security Requirements				
			Describe all cost associated with this section.	NO COST TO DOC	NO COST TO DOC
3.4	Maintenance/ Service				
		3.4.1	Software Modification/Release Mgt		
				NO COST TO DOC -- SEE BELOW	NO COST TO DOC -- SEE BELOW
3.5	Reporting				
			List any cost associated with this section. If none, list N/A	NO COST TO DOC	NO COST TO DOC
3.6	Training and Support				
			Describe all cost associated with this section.	NO COST TO DOC -- SEE BELOW	NO COST TO DOC -- SEE BELOW
3.7	System Warranty				
			List any cost associated with this section. If none, list N/A.	NO COST TO DOC -- SEE BELOW	NO COST TO DOC -- SEE BELOW
3.8	DRC Security Requirement				
			Not Applicable		
3.9	Optional/Other Services				
			Describe all cost associated with this section.	NO COST TO DOC	NO COST TO DOC
3.10	Documentation				
			List any cost associated with this section. If none, list N/A.	NO COST TO DOC	NO COST TO DOC

Keefe Group proposes to provide all hardware and all wiring and installation of inmate ordering kiosks at NO COST to Nevada Department of Corrections. Keefe will provide all software, on-going training and 24-hour 365 days a year support.

Keefe Group has a dedicated Technical Specialist within our region and employs an entire department of technicians at our corporate office. We also have a dedicated Vice President and Account Manager based out of our Reno office to handle this contract. Our turnkey solution offers you one point of contact should there be an issue with any of these services. Any and

all upgrades of hardware and software and additional training to facility staff will be provided by Keefe Group at no cost to the State for the life of the Agreement. We have a strong working relationship with Shawntec Communications, Inc. Shawntec currently has employees cleared by Nevada DOC and already working in the field. This relationship provides us additional options should a need arise.

Keefe Group has no hidden fees or maintenance costs, no processing fees, and no installation fees.

	Commission		DRC Commission		
			Email/Secure Messaging	\$0.10	
			Inmate Banking (deposits)	\$1.00	
			MP3 Player Sales	6.0%	
			MP3 Song Sales	\$0.20	
			Video Visitation	20.00%	

Under Proposal Two:

- Keefe would no longer offer the department an additional three (3) percent commission on total commissary sales.
- Keefe offers the Nevada Department of Corrections a \$.10 commission on each Email/Secure Messaging and Photo transaction.
- Keefe offers the Nevada Department of Corrections a \$1.00 commission on each Secure Deposits transaction, with the exception of those made through our lock box option. For convenience sake, Keefe has offered our lock box service at **no charge** to the inmate family and friends. Should the department wish to receive a commission on this service, Keefe will gladly adjust pricing.
- Keefe offers the Nevada Department of Corrections a six percent (6%) commission on each MP3 player sold.
- Keefe offers the Nevada Department of Corrections \$.20 on each MP3 song downloaded.
- Keefe offers the Nevada Department of Corrections 20% of all video visitation revenue.

Should the department wish to negotiate rates and/or commissions, Keefe is willing to discuss.

		State	Nevada	Participating States
	Related Equipment			
		MP3 MINI MAXX PLAYER	\$49.99	
		MP3 MAXX PLAYER (4GB)	\$79.95	
		MP3 MAXX PLAYER (8GB)	\$99.95	
		MP3 MAXX TOUCH PLAYER (4GB)	\$99.95	
		MP3 MAXX TOUCH PLAYER (8 GB)	\$129.95	
		MP3 MAXX SLIDE PLAYER (8 GB)	\$159.95	
		MP3 MAXX SLIDE PLAYER (16 GB)	\$199.95	
		MP3 SONGS	\$1.80	

Keefe offers a wide selection of player options to the inmate population. We are the only proven MP3 provider, with eight (8) existing state DOC customers and another two (2) in implementation stage. Our players have been designed specifically for use in the correctional environment and therefore built to withstand the rigors associated. We have included samples of our Maxx MP3 player, along with a keyboard and the life skills programs on CD in all of the technical responses. . Additionally, our MP3 player allows inmates to choose songs from the player rather than having to search from the kiosk. The significant additional time required for inmates to search from the kiosk (as opposed to on the player on their own time) can create disruption within the facility as well as puts an additional burden on the kiosk itself. Keefe's MP3 accessories include, but are not limited to, clear plastic keyboards and armbands.